

Models **ESM303** & **ESM303H**

FORCE TEST FRAMES

User's Guide

MARK-10[®]

Thank you...



Thank you for purchasing a Mark-10 ESM303 / ESM303H Force Test Stand, designed for producing up to 300 lbF (1.5 kN) of tension and compression force. The ESM303 / ESM303H is an essential component of a force testing system, typically also comprising a force gauge, or load cell with indicator, and grips.

With proper usage, we are confident that you will get many years of great service with this product. Mark-10 test stands are ruggedly built for many years of service in laboratory and industrial environments.

This User's Guide provides setup, safety, and operation instructions. Dimensions and specifications are also provided. For additional information or answers to your questions, please do not hesitate to contact us. Our technical support and engineering teams are eager to assist you.

Note:

Except where otherwise indicated, references to "ESM303" include models ESM303 and ESM303H.

Before use, each person who is to use the test stand should be fully trained in appropriate operation and safety procedures.

TABLE OF CONTENTS

OVERVIEW	3
SETUP AND SAFETY	6
OPERATION BASICS	12
TEST FUNCTION SETUP	14
OPERATING MODES	27
COMMUNICATION	34
FUNCTION ACTIVATION	37
INSTALLING THE SHIELD OPTION	38
INSTALLING THE TRAVEL INDICATION OPTION	39
INSTALLING A COLUMN EXTENSION OPTION	41
MAINTENANCE AND SERVICE	44
TROUBLESHOOTING	45
SPECIFICATIONS	46
DIMENSIONS	47

1 OVERVIEW

1.1 List of included items

1.1.1 ESM303

Qty.	Description
1	Force gauge mounting adapter
4	Force gauge / indicator mounting screws, #6-32 x 1/2
2	Limit switch thumb screws, #6-32 x 5/8
1	Control panel with ball mount
1	Control panel mounting bracket with hardware (shipped installed)
1	Accessories kit: <ul style="list-style-type: none"> - #10-32F small hook - #10-32M medium hook - #10-32F 2" diameter comp. plate - #10-32 F/F coupler - Adapter, 5/16-18M to #10-32F - Set screw, #10-32 x 3/4" (3) - Hex nut, #10-32 (3) Allen wrench set
1	Power cord

1.1.2 ESM303H

Qty.	Description
1	Indicator / load cell mounting adapter
4	Indicator mounting screws, #6-32 x 1/2
2	Limit switch thumb screws, #6-32 x 5/8
1	Control panel
1	Control panel mounting bracket
1	Adapter, control panel bracket to frame (shipped installed)
2	Screws for mounting control panel bracket to adapter, #8-32 x 1" (shipped installed)
2	Screws for mounting adapter to frame, #10-32 x 1" (shipped installed)
2	Screws for mounting control panel to bracket, 1/4-28 x 1-1/4", with lock washers
1	Accessories kit: <ul style="list-style-type: none"> - #10-32F small hook - #10-32M medium hook - #10-32F 2" diameter comp. plate - #10-32 F/F coupler - Adapter, 1/2-20M to #10-32F - Adapter, 1/4-28M to 5/16-18F - Adapter, 5/16-18M to #10-32F (2) - Set screw, #10-32 x 3/4" (3) - Hex nut, #10-32 (3) - Allen wrench set
1	Power cord

Additional optional items are available, such as an adjustable base plate, connection cables, and column extensions. Instructions for installing a column extension and retrofitting the test stand with the travel indication option are provided later on in this user's guide.

1.2 Physical features

Note the following physical features. The user's guide will reference this terminology.

1.2.1 ESM303



1.2.2 ESM303H

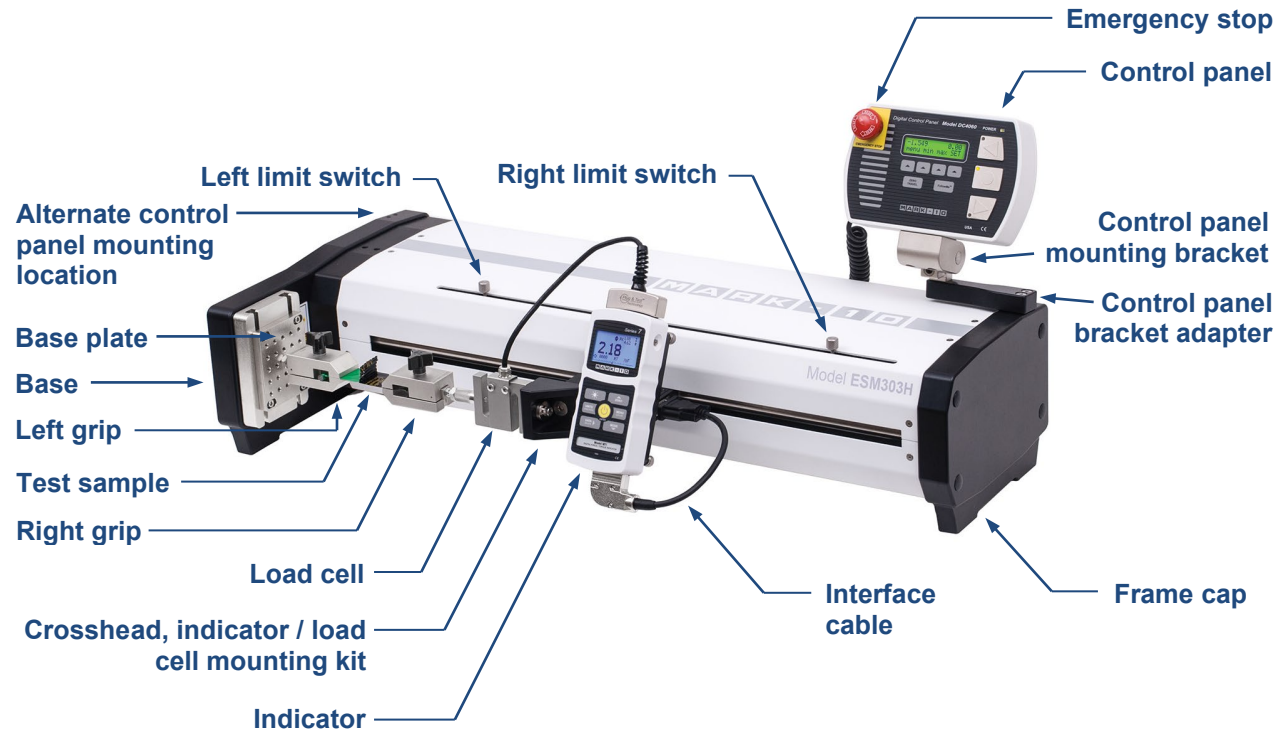

2 SETUP AND SAFETY

2.1 Mounting

Place the stand on a clean, flat and level work area free from vibration.

For the vertically oriented ESM303, it is suggested to mount the stand to a work bench via screws fastened into the underside of the base. Failure to properly mount the test stand may make it more vulnerable to tipping, especially if a column extension is used, causing a hazardous situation.

2.2 Mounting the control panel

To avoid damage during shipment, the control panel is packaged separately. Follow these installation instructions:

2.2.1 ESM303

The control panel mounting bracket is shipped installed, as shown below:



1. Loosen the plastic wing nut so that the arm is loose, and the end is opened wide to accommodate the ball mount in the rear of the control panel, shown below:



2. Mate the ball end to the arm, adjust the viewing angle as desired, then tighten the wing nut. The control panel should now appear as follows:



2.2.2 ESM303H

Attach the control panel as described below:

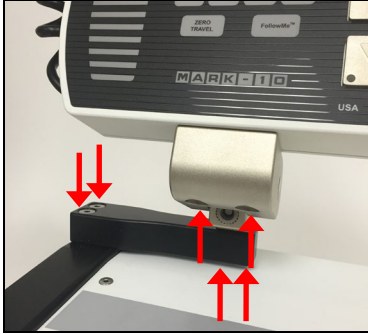

1. Install the control panel to the mounting bracket utilizing two 1/4-28 screws.
2. Install the mounting bracket to the bracket adapter with two #8-32 screws.
3. Install the bracket adapter to the edge of the test frame with two #10-32 screws. This may be done on either the right end or the left end of the frame, where sets of #10-32 holes are provided.
4. The viewing angle may be adjusted by loosening the lever in the rear of the bracket, positioning the control panel, and re-tightening the lever.

2.3 Limit switches

Upper and lower limit switches are supplied to stop travel in both directions. The limit switch thumb screws are shipped banded together, as illustrated below:



Remove the rubber band and instructional tag before use. Refer to later sections for more detailed information about limit switches.

2.4 Connections and outputs

The following connections and outputs are supplied in the rear of the test stand, as shown in the illustration below:

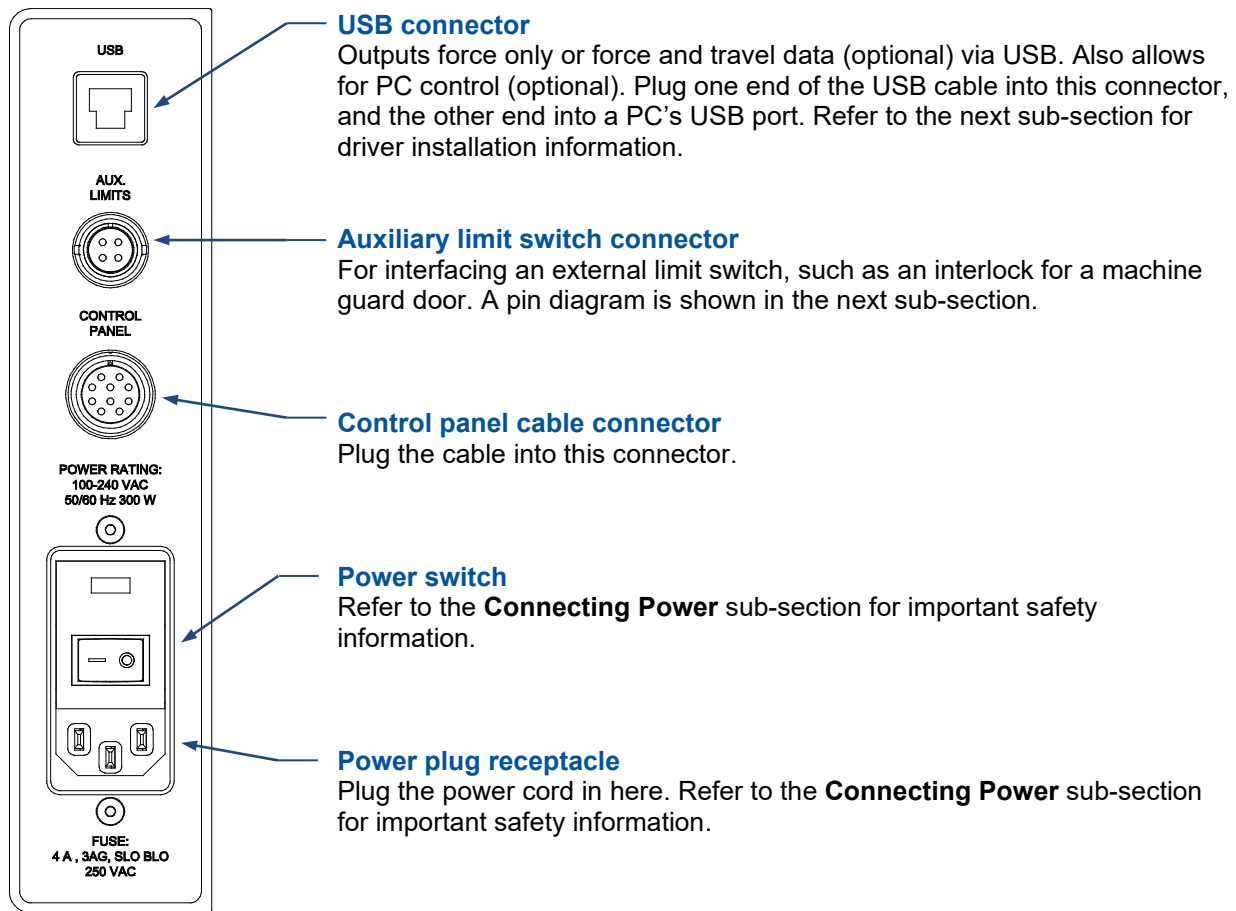

2.4.1 Auxiliary limit switch pin diagram

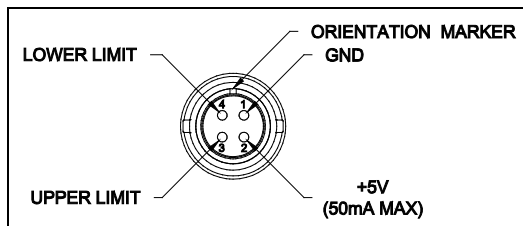

Note that when pins 3 and 4 are not connected, the auxiliary limits are inactive. When the +5V from pin 2 is connected to either pin 3 or pin 4, the respective limit becomes active and the crosshead is prevented from movement in that direction.

2.4.2 USB driver installation

To use this output, download and install the USB driver from www.mark-10.com/resources.

Caution!

Install the USB driver before physically connecting the tester to a PC with the USB cable.

Further instructions for configuring communication parameters may be found in the **Test Function Setup** section. If PC control is used, a full listing of available ASCII commands may be found in the **Operating Modes** section.

2.5 Installing a force gauge or indicator with load cell

2.5.1 ESM303

Once the test stand is in a stable and secure position, install a force gauge by mating the dowel pin in the force gauge mounting plate with the blind hole in the rear of the force gauge's housing. Use the four thumb screws to secure the gauge. Grips and fixtures may be threaded onto the force gauge and test stand base.

2.5.2 ESM303H



1. Once the test stand is in a stable and secure position, install an indicator via four thumb screws.
2. Install a load cell to the crosshead using the supplied hardware, and insert the Plug & Test[®] connector into the indicator, as shown in the image at left.

2.6 Installing an indicator / load cell mounting kit (optional for ESM303)

The optional AC1062 mounting kit is available to mount a Series R01 or Series R03 load cell (force sensor) and an indicator onto the crosshead, instead of a force gauge. To install, follow these instructions:

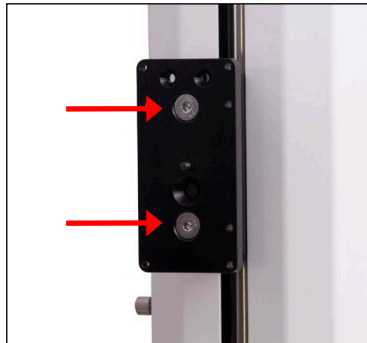

1. Remove the force gauge mounting plate by loosening the two 5/16-18 flat head screws, as shown at left.



2. Install the indicator bracket onto the side of the crosshead, utilizing two #10-32 flat head screws, as shown at left.



3. Install the L-bracket with the same two flat head screws, as shown at left.



4. Mount the load cell to the L-bracket utilizing the included hardware, as shown at left.



5. Mount the indicator utilizing the four provided thumb screws, and insert the Plug & Test[®] connector into the indicator. Orient the housing of the indicator such that the connector is pointed downwards. Refer to the indicator's user's guide for details.

2.7 Installing the AC1114 / AC1115 interface cable

If using test stand functions requiring communication between the force gauge / indicator and test stand, such as data output, overload protection, preload, etc., connect the interface cable between the instrument's connector and the crosshead's connector. This cable may be used with a Series 4, 5, or 7 instrument. Refer to the image below:



AC1114 (ESM303)

or



AC1115 (ESM303H)

Note:

The AC1114 and AC1115 cables power the instrument. When connected, the instrument automatically powers on when the test stand is powered on. The instrument's AC adapter is not necessary under these conditions.

2.8 Safety / proper usage

Typical materials able to be tested by the ESM303 include many raw materials and manufactured items, such as springs, metals, plastics, electronic components, mechanical assemblies, packaging materials, and many others. Potentially flammable substances or products should not be used with the ESM303. For samples which can shatter or otherwise present a physical danger to the operator, a shield is required, such as model no. ESM303-003. Refer to the **Shield** section for installation instructions.

Ensure that the grip or fixture is positioned to ensure axial load with respect to the load axis of the load cell or force gauge. When using a grip, ensure that it secures the sample in such a way that it is prevented from slipping out during a test, preventing a potential safety risk to the operator and others in the vicinity. If using a grip or fixture from a supplier other than Mark-10, ensure that it is constructed of suitably rugged materials and components.

A shield is recommended

2.9 Connecting power

Plug one end of the power cord into its receptacle at the rear of the stand and the other end into a wall outlet with local earth ground (3-prong connector).

Before turning on power, the following safety checks and procedures should be performed:

1. Never operate the test stand if there is any visible damage to the power cord or the test stand itself. The ESM303 is powered by 110V/220V. Any contact with this high voltage can cause serious injury or even death.
2. Ensure that the test stand is kept away from water or any electrically conductive liquids at all times.
3. Make sure the electrical outlet powering the test stand has local earth ground (3-prong connector).
4. The test stand should be serviced by a trained technician only. Power must be disconnected before the column covers are removed.

After the above safety checks and procedures have been performed, the test stand may be powered on and is ready for operation.

3 OPERATION BASICS

3.1 Operational safety

The following safety checks and procedures should be performed before and during operation:

1. Always consider the characteristics of the sample being tested before initiating a test. A risk assessment should be carried out beforehand to ensure that all safety measures have been addressed and implemented.
2. Wear eye and face protection when testing, especially when testing brittle samples that have the potential to shatter under force. Be aware of the dangers posed by potential energy that can accumulate in the sample during testing. Extra bodily protection should be worn if a destructive failure of a test sample is possible.
3. Keep away from moving parts of the test stand. Loose articles of clothing should not be worn. Long hair should be covered to avoid a hazardous situation. A Crush Hazard warning label is located on the base of the test stand. It appears as follows:



Definition: Keep any body parts and clothing clear of the area between the base of the test stand and the moving crosshead.

4. In those applications where samples can shatter, or other applications that could lead to a hazardous situation, use of a machine guard is strongly recommended.
5. When the test stand is not in use, ensure that the power is turned off to prevent accidental engagement of any of the controls.

3.2 Controls

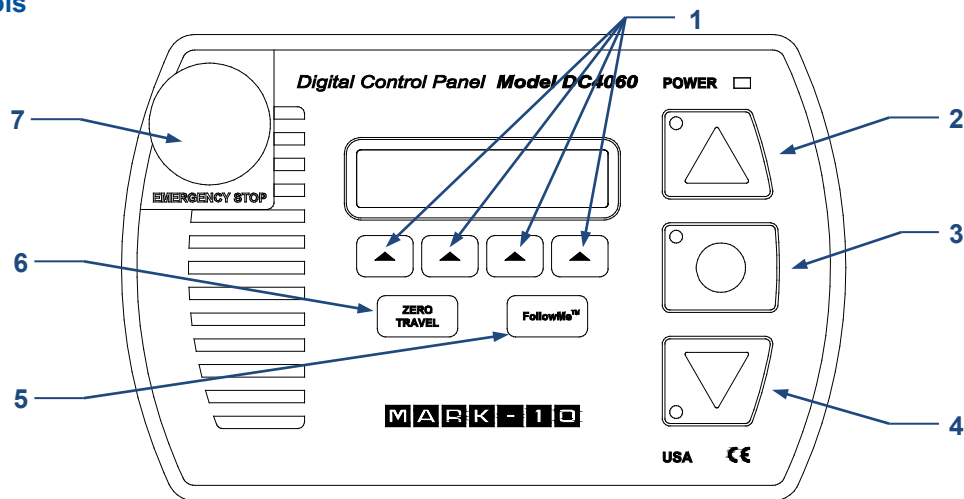

	Label	Function
1	SOFT KEYS	Functions are determined by the corresponding text on the display.
2	UP / RIGHT	Commences movement in the up (ESM303) or right (ESM303H) direction.
3	STOP	Stops crosshead movement.
4	DOWN / LEFT	Commences movement in the down (ESM303) or left (ESM303H) direction.
5	FollowMe®	Enables force-activated crosshead positioning. If this option is not installed, the message "NOT INSTALLED" flashes.
6	ZERO TRAVEL	Zeroes the travel display. If this option is not installed, the message "NOT INSTALLED" flashes.
7	EMERGENCY STOP	Press this button at any time to stop test stand motion. Rotate clockwise to release.

3.3 Modes overview

The ESM303 has three functional modes:

1. OPERATING MODE

This is the operating mode in which testing sequences can be started and stopped.

2. TEST FUNCTION SETUP

In this mode, test functions are configured, such as rate of speed, number of cycles, password editing, and other functions.

3. FUNCTION ACTIVATION

Many test stand functions, such as cycling, auto return, distance measurement, and others are ordered individually as options. The Function Activation menu provides a means of identifying which functions were purchased. Through this menu, it is also possible to enable any functions not originally purchased via an activation code. All functions are temporarily enabled for the first 160 hours of operation, as described below:

DEMO MODE

The ESM303 is shipped in *Demo Mode*, during which time all available functions are temporarily activated for 160 hours of operation. At power-up, a counter displays the number of hours remaining, as follows:



**REMAINING DEMO
TIME : 160 HOURS**

Press **STOP** to continue.

At the end of this period, any functions not originally purchased will be deactivated, and will no longer be accessible from the **Test Function Setup** menu. *Demo Mode* can be suspended at any time by pressing and holding **STOP** while turning on power to the test stand. This mode can be re-enabled in the same manner, and will be active for the remaining time period.

Refer to the **Function Activation** section for instructions for field activation.

4 TEST FUNCTION SETUP

This section provides configuration instructions for each function.

Function	Standard / Optional
Travel indication	Optional
Speed - same setting applies to both directions	Standard
Independent up and down speeds	Optional
High speed range extension	Optional
Low speed range extension	Optional
Auto return	Optional
Cycling with dwell time	Optional
Programmable travel limits	Optional
Overload protection	Optional
Preload	Optional
Loadholding	Optional
Break detection	Optional
PC control	Optional
FollowMe™	Optional
Profiles	Optional
Communication settings	Standard
Speed / distance unit of measurement	Standard
Directional button configuration	Standard
Password protection	Standard

All ESM303 test stands are supplied in *Demo Mode*, as explained in the **Overview** section. After *Demo Mode* expires, only installed functions will be displayed in **Test Function Setup**. To access Test Function Setup menu, press **menu** from the Operating Mode home screen, which appears as follows:

SPEED : 0.00
menu min max SET

After pressing **menu**, the initial Test Function Setup screen appears as follows:

```
SPEED :      20 . 00
ESC  <-  ->  ENTR
```

Label	Description
ESC	Exits Test Function Setup, reverts to Operating Mode
< -	Scrolls to the previous function
- >	Scrolls to the next function
ENTR	Selects the function, allowing it to be modified

When the functions have been configured and are ready to be saved, press **ESC** to exit Test Function Setup.

Note:

Changes can be made to an unlimited number of settings before saving.

If the **PROFILES** function is installed, the changes may be saved to the desired profile name. The screen appears as follows:

```
SAVE AS : EXAMPLE 1
ESC  +  EDIT  SAVE
```

Label	Description
ESC	Exits Test Function Setup, reverts to Operating Mode
+	Scrolls to the next saved profile
EDIT	Press to edit the profile name. The first character will be flashing. Press + to change the character and -> to advance to the next character.
SAVE	Saves the settings under the specified profile name

Refer to the **Profiles** sub-section for further details on selecting and deleting profiles.

If **PROFILES** is not installed, the screen appears as follows:

```
SAVE CHANGES?
NO                YES
```

Make the appropriate selection.

4.1 Speed

If the Independent Speeds option has not been installed, both directional speeds will be the same, and is programmed via the **SPEED** function. If the Independent Speeds option is installed, **UP SPEED / RIGHT SP** and **DN SPEED / LEFT SP** functions will be present, and may be set individually.

Default setting: 10 in/min / 250 mm/min

Available settings: 0.02 – 45 in/min / 0.5 – 1,100 mm/min

```
UP SPEED : 10.73
ESC - + ENTR
```

Label	Description
+	Increments the speed setting. Holding down + will increment at an increasingly faster rate.
-	Decrements the speed setting. Holding down - will decrement at an increasingly faster rate.
ENTR	Returns to the Test Function Setup menu
ESC	Exits the function without saving changes

4.2 Auto return

With this function, the crosshead moves to a limit switch or *soft limit* (force set point, distance limit, preload, or break), whichever occurs first, and stops. Then, the crosshead returns to the other limit and stops. The test speed is dictated by the setting described in the previous section. The return speed is locked to maximum speed. The maximum speed depends on whether or not the optional high speed range has been installed.

Default setting: off

Available settings: off, on

```
AUTO RETURN off
ESC - + ENTR
```

Label	Description
+ or -	Cycles through the available settings
ENTR	Returns to the Test Function Setup menu
ESC	Exits the function without saving changes

Note:

If **AUTO RETURN** is turned **on**, **CYCLING** is automatically turned **off** and the **KEYS** function is automatically set to **MAINTAINED** mode. See following pages for details on the **CYCLING** and **KEYS** functions.

4.3.1 Cycling (CYCLES)

This setting allows the user to configure the number of up and down cycles through which the crosshead will sequence. One cycle consists of the crosshead moving to a limit switch or *soft limit*, whichever occurs first, at the specified speed, stopping for the specified amount of dwell time, and returning to the other limit at the specified speed. If the Independent Speeds function is not enabled, the speed will be the same in both directions.

Default setting: 00000 (off)

Available settings: 00000 – 99999

CYCLES :	00000
ESC	- + ENTR

Label	Description
+	Increases the number of cycles in increments of 1. Holding down + will increment at an increasingly faster rate. If 99999 is reached the next number will be 00000 and continue incrementing.
-	Decreases the number of cycles in increments of 1. Holding down - will decrement at an increasingly faster rate. If 00000 is reached the next number will be 99999 and continue decrementing.
Press and hold + and - simultaneously	If pressed and held for 2 seconds or longer the number of cycles will change to 0.
ENTR	Returns to the Test Function Setup menu
ESC	Exits the function without saving changes

4.3.2 Dwell times (HI / R DWELL and LO / L DWELL)

This setting corresponds to the amount of time, in seconds, for which the crosshead stops at the limit during a cycle sequence. Individually set dwell times can be applied to the upper and lower (or right and left) limits.

Note:

The dwell time setting is unavailable for an auto return sequence.

Default setting: 0 (no dwell time)

Available settings: 0 – 9999.9

HI DWELL :	0000.0
ESC	- + ENTR

Label	Description
+	Increases dwell time in increments of .1. Holding down + will increment at an increasingly faster rate. If 9999.9 is reached the next number will be 0 and continue incrementing.
-	Decreases dwell time in increments of .1. Holding down - will decrement at an increasingly faster rate. If 0 is reached the next number will be 9999.9 and continue decrementing.
ENTR	Returns to the Test Function Setup menu
ESC	Exits the function without saving changes

4.4 Travel limits (HI LIMIT / RIGHT LM and LO LIMIT / LEFT LM)

Travel limits may be programmed as specified distances, either as upper and lower limits, or right and left limits. The crosshead stops when the distance limits have been reached.

Default settings: Upper / Right: +20.000 in, Lower / Left: -20.000 in

Available settings: From -20.000 to +20.000 in

```

HI LIMIT : 2.058
ESC - + ENTR
  
```

Label	Description
+	Increments the travel limit setting by .001 in or .02 mm. Holding down + will increment at an increasingly fast rate.
-	Decrements the travel limit setting by .001 in or .02 mm. Holding down - will increment at an increasingly fast rate.
ENTR	Returns to the Test Function Setup menu
ESC	Exits the function without saving changes

4.5 Overload protection (OVERLD)

4.5.1 Function

The ESM303 protects a load cell or force gauge from overload by measuring incoming analog voltage and stopping crosshead travel when the programmed percentage of full scale has been reached. The default setting is for Mark-10 instruments ($\pm 1V$ full scale), however, the setting may be changed to $\pm 2V$ or $\pm 4V$ to accommodate other instruments.

Default setting: OFF

Available settings: MARK-10, OTHER 2V, OTHER 4V, OFF

```

OVERLD : MARK - 10
ESC - + ENTR
  
```

Label	Description
+ or -	Cycles through the following available settings:
MARK-10	$\pm 1V$ full scale
OTHER 2V	$\pm 2V$ full scale
OTHER 4V	$\pm 4V$ full scale
OFF	Overload protection is disabled
ENTR	Returns to the Test Function Setup menu
ESC	Exits the function without saving changes

4.5.2 Compression and tension overload settings (COMP OVERLD and TEN OVERLD)

This setting corresponds to the percentage of full scale at which crosshead travel stops. For example, a setting of 80% for a 100 lbF capacity force gauge would stop crosshead travel when approximately 80 lbF is reached.

Note:

Overload protection is active only for forces applied in the same direction of travel.

Default setting: 100%

Available settings: 20% - 120% (10% increments)

```
COMP OVERLD : 100%
ESC - + ENTR
```

Label	Description
+ or -	Increases or decreases the value.
ENTR	Returns to the Test Function Setup menu
ESC	Exits the function without saving changes

4.6 Preload

4.6.1 Function

This setting corresponds to the test stand's response to an initial load, referred to as a *preload*. The crosshead can stop and/or zero the travel display when the preload has been reached. This function is useful for applications such as spring testing, elongation testing, and tensile and compression testing of various materials. In effect, it establishes a reference point. It is also sometimes referred to as a *touch*.

Note:

Before the start of a preload sequence, the crosshead must be positioned at either **physical** limit switch.

Default setting: OFF

Available settings: STOP, STOP/ZERO, ZERO/GO, OFF

```
PRELOAD : ZERO , GO
ESC - + ENTR
```

Label	Description
+ or -	Cycles through the available settings listed below:
STOP	Crosshead stops when preload has been reached
STOP, ZERO	Crosshead stops when preload has been reached, then zeroes the travel display
ZERO, GO	Travel display is zeroed when preload has been reached, crosshead does not stop
ENTR	Returns to the Test Function Setup menu
ESC	Exits the function without saving changes

4.6.2 Preload Value (PRELD %FS)

This setting corresponds to a preload value, defined as a percentage of the instrument's full scale in lbf units. The test stand's response, as described in the previous section, occurs when this value has been reached.

Note:

In low force applications, consider test stand vibration and crosshead acceleration, as they can be significant enough to produce a force exceeding the preload value.

Default setting: 1%

Available settings: 0 – 100%

```
PRELD %FS : 01.0
ESC - + ENTR
```

Label	Description
+ or –	Increases or decreases the value, in increments of .1
ENTR	Returns to the Test Function Setup menu
ESC	Exits the function without saving changes

4.7 Load holding

This setting directs the test stand to dynamically adjust the crosshead position to maintain a programmed force. The force is programmed as a set point in a Series 5 or 7 instrument (refer to the user's guide for details). If the **CYCLING** option has been installed, load holding will be active for the period of time as defined in dwell settings. If **CYCLING** has not been installed, load holding will continue indefinitely. Pressing **STOP** will end load holding.

Default setting: OFF

Available settings: ON, OFF

```
LOAD HOLDING : ON
ESC - + ENTR
```

Label	Description
+ or –	Cycles through the available settings
ENTR	Returns to the Test Function Setup menu
ESC	Exits the function without saving changes

4.8 Break detection

4.8.1 Setting

This setting directs the test stand to stop when a sample break has occurred. The test stand stops when the force has decreased to a specified percentage of peak.

Default setting: OFF

Available settings: ON, OFF

```
BREAK DETECT : ON
ESC   -   +   ENTR
```

Label	Description
+ or -	Cycles through the available settings
ENTR	Returns to the Test Function Setup menu
ESC	Exits the function without saving changes

4.8.2 Activation threshold

This setting corresponds to the force threshold after which the break detection function is active. The threshold is provided to prevent false activation of the function during sample handling. The threshold is defined as a percentage of full scale of the load cell or force gauge. For example, for a 50 lbF capacity force gauge, a setting of 10% represents 5 lbF.

Default setting: 10%

Available settings: 1% - 95% (1% increments)

```
BRK THRESH : 80%
ESC   -   +   ENTR
```

Label	Description
+ or -	Increases or decreases the value.
ENTR	Returns to the Test Function Setup menu
ESC	Exits the function without saving changes

4.8.3 Percentage of peak

This setting corresponds to the force trigger for break detection, defined as a percentage of peak force. For example: A sample is tensioned, and breaks at 50 lbF. The break detection percentage setting is 60%. After the sample breaks, the force rapidly decreases to 30 lbF (60% of peak), and the stand stops.

Default setting: 80%

Available settings: 1% - 95% (1% increments)

```
BREAK % PEAK : 10
ESC - + ENTR
```

Label	Description
+ or -	Increases or decreases the value.
ENTR	Returns to the Test Function Setup menu
ESC	Exits the function without saving changes

Note:

When using an ESM303 / ESM303H test stand with a Series 7 instrument, enable **Break Detection** in either the test stand or the instrument. The function will not work if simultaneously enabled in both devices.

4.9 Control source (CONTROL)

This setting corresponds to the source of test stand control, as follows:

CONSOLE

The test stand is controlled either from the control panel or from *MESURgauge Plus* software running on a PC.

PC

The test stand is controlled from a custom written PC application (not *MESURgauge Plus*). If any functions are changed on the front panel, these settings will be ignored, except for **Auto Return** or **Cycling**. If either of these functions is turned on, PC control will be turned off.

Default setting: CONSOLE

Available settings: CONSOLE, PC

```
CONTROL : CONSOLE
ESC - + ENTR
```

Label	Description
+ or -	Cycles through the available settings
ENTR	Returns to the Function Setup menu
ESC	Exits the function without saving changes

4.10 Baud rate

This setting corresponds to the baud rate setting of the computer program controlling the test stand.

Default setting: 115200

Available settings: 1200, 2400, 4800, 9600, 19200, 38400, 57600, 115200

```
BAUD RATE : 115200
ESC      -   +   ENTR
```

Label	Description
+ or -	Cycles through the available settings
ENTR	Returns to the Function Setup menu
ESC	Exits the function without saving changes

4.11 Stop bits and parity (STOP & PAR)

This corresponds to the stop bits and parity settings of the computer program controlling the stand.

Default setting: 8-1n

Available settings:

```
8-1E  8 stop bits, 1 stop bit, even parity
8-1o  8 stop bits, 1 stop bit, odd parity
8-1n  8 data bits, 1 stop bit, no parity
8-2n  8 data bits, 2 stop bits, no parity
7-1E  7 data bits, 1 stop bit, even parity
7-1o  7 data bits, 1 stop bit, odd parity
7-2E  7 data bits, 2 stop bits, even parity
7-2o  7 data bits, 2 stop bits, odd parity
7-2n  7 data bits, 2 stop bits, no parity
```

```
STOP & PAR : 8 - 1 n
ESC      -   +   ENTR
```

Label	Description
+ or -	Increases or decreases the value
ENTR	Returns to the Test Function Setup menu
ESC	Exits the function without saving changes

4.12 Units of speed (UNITS)

This setting corresponds to units of speed measurement.

Default setting: in/min

Available settings: in/min, mm/min

```
UNITS :      i n / m i n
ESC      -   +   ENTR
```

Label	Description
+ or -	Cycles through the available settings
ENTR	Returns to the Test Function Setup menu
ESC	Exits the function without saving changes

4.13 Programmable button function (KEYS)

Three button function modes are available:

1. Maintained

The crosshead will move continuously once the button has been pressed and held. Subsequently pressing STOP will stop crosshead motion.

2. Momentary

The crosshead will move only if the button is held down. Releasing the button will stop movement immediately.

3. Auto

Holding down the button for more than 0.5 second will enter momentary mode, at which time an audible indicator will sound and the LED indicator on the button pushed will be illuminated. A short tap on the button will operate the test stand in maintained mode. Pressing STOP during maintained mode will stop crosshead motion.

Default setting: auto

Available settings: maintained, momentary, auto

```
KEYS : MAINTAINED
ESC   -   +   ENTR
```

Label	Description
+ or -	Cycles through the available settings
ENTR	Returns to the Test Function Setup menu
ESC	Exits the function without saving changes

4.14 FollowMe®

Crosshead responds to manually pushing or pulling on the force gauge shaft or load cell. Increasing force produces greater speeds. Ideal for quick positioning during sample loading and unloading.



CAUTION!

Exercise extreme caution when handling low capacity force gauges and sensors, as overload can occur.

Default setting: OFF

Available settings: ON, OFF

```
FOLLOWME:    OFF
ESC   -   +   ENTR
```

Label	Description
+ or -	Cycles through the available settings
ENTR	Returns to the Test Function Setup menu
ESC	Exits the function without saving changes

4.15 Profiles

4.15.1 Save a new profile

To save a new profile, configure the menu settings as required, then exit the menu. When prompted to save changes, press **YES**. The display appears as follows:

```
Save as : - - -
ESC + EDIT SAVE
```

Press **+** until the profile name “ - - - ” is displayed. Then, press **EDIT**. The display appears as follows:

```
PROFILE : - - -
ESC + > SAVE
```

Press **+** to increment the flashing character, and **>** to advance to the next character. The profile name can consist of up to 8 characters. When complete, press **SAVE**. Up to 50 profiles may be saved. Press **ESC** to exit without saving changes.

4.15.2 Load a previously saved profile

```
PROFILE : PEELTEST
ESC - + ENTR
```

Press **+** and **-** to cycle through the profiles, then press **ENTR**. Press **ESC** to exit without saving changes.

4.15.3 Change a profile name

Refer to the instructions in the **Save a new profile** sub-section. Scroll to the appropriate profile, then press **ENTR** and follow the same procedure.

4.15.4 Delete a profile

```
DEL . PR : PEELTEST
ESC - + ENTR
```

Press **ESC** to exit without saving changes.

Press **+** and **-** to cycle through the profiles, then press **ENTR** to delete. The screen will prompt, “DELETE PROFILE?” Select **YES** or **NO**.

Note: the profile “DEFAULT” cannot be deleted, and will not appear in the list.

4.16 Default settings

Revert to the following factory settings:

SPEED:	10 in/min
UP / RIGHT SPEED:	10 in/min
DOWN / LEFT SPEED:	10 in/min
AUTO RETURN:	off
CYCLING:	00000 (off)
HI / RIGHT LIMIT:	+20.000 in
LO / LEFT LIMIT:	-20.000 in
OVERLOAD PROTECTION:	off
PRELOAD:	off
LOAD HOLDING:	off
BREAK DETECTION:	off
PROFILE:	DEFAULT
CONTROL:	CONSOLE
BAUD RATE:	115200
STOP BITS & PARITY:	8-1n
UNIT:	in/min
KEYS:	auto
FOLLOWME:	off
PASSWORD:	0000 (off)

If the **PROFILES** function is installed, the test stand will revert to the profile named "DEFAULT". This profile contains the factory settings listed above, and may not be edited.

If the **PROFILES** function is not installed, the display appears as follows:

```

DEFAULT ? :      NO
ESC  -  +  ENTR
  
```

Label	Description
+ or -	Cycles through "yes" or "no" selections
ENTR	Returns to the Test Function Setup menu
ESC	Exits the function without saving changes

4.17 Password (NEW PWORD)

If desired, a password can be set to prevent unwanted changes to test functions. The password can be set to any number between 0000 and 9999. The default setting of 0000 indicates that the password is disabled, and that the user can freely enter the Test Function Setup menu. If misplaced or forgotten, the password may be reset through a code activation process. Details on this may be found in the **Function Activation** section.

Default setting: 0000 (off)

Available settings: 0000 – 9999

```

NEW PWORD      0 0 0 0
ESC  -  +  ENTR
  
```

Label	Description
+ or -	Increases or decreases the value.
ENTR	Returns to the Test Function Setup menu
ESC	Exits the function without saving changes

5 OPERATING MODES

5.1 Overview

The ESM303 can be operated in several modes, including combinations of these modes:

1. **FollowMe® Mode**
Crosshead movement responds to pushing or pulling on the force gauge shaft or load cell. Increasing force produces greater speeds. Useful for quick positioning during setup and sample loading/unloading.
2. **Basic Mod**
Manual control of crosshead motion.
3. **Auto Return Mode**
Crosshead moves to a limit switch or force set point, travel distance, preload, or sample break (referred to as *soft limits*), whichever occurs first. Then, it reverses and moves at maximum speed to the other limit, whichever occurs first.
4. **Cycling Mode**
Crosshead cycles between limits at the selected speed(s), and pauses at each limit or set point for a selected period of time.
5. **Preload Mod**
Crosshead moves until the preload has been reached, and performs the action programmed in the setting. An auto-return, cycle/dwell time, or break detection sequence may follow.
6. **Load holding Mode**
Crosshead moves to a force set point, stops, then dynamically adjusts position to maintain the programmed force. An auto-return or cycle/dwell time sequence may follow.
7. **Break Detection Mode**
Crosshead stops when a sample break has been detected. An auto-return or cycle/dwell time sequence may follow.
8. **PC Control Mode**
See Communications section.

The Operating Mode home screen appears as follows:

```
SPEED :      0 . 0 0
menu min max SET
```

If the travel indication option is installed, the screen appears as follows:

```

POSITION      SPEED
  ↓           ↓
1 . 2 7 5      0 . 0 0
menu min max SET
```

The item selected will be capitalized, as shown in the figure above. The **set** speed can be changed in Test Function Setup. If enabled, independent directional speeds may be set.

5.2 Menu navigation

At power-up, the display will show the operation screen for whichever mode was used last. The display will appear as one of the following:

1. **Basic & Auto Return Modes** (travel indication option not installed):

```
SPEED :      0 . 0 0
menu min max SET
```

2. **Basic & Auto Return Modes** (travel indication option installed):

```
POSITION      SPEED
  ↓            ↓
1 . 2 7 5      0 . 0 0
menu min max SET
```

3. **Cycling Mode** (travel indication option not installed):

```
CYCLES :      0 0 0 2 4
menu min max SET
```

Note:

The **min** and **max** keys will not appear when a password has been set.

4. **PC Control Mode**

Appears the same as in Basic and Auto Return modes.

Label	Description
menu	Enters Test Function Setup
min	Sets speed to minimum speed. Will not appear when a password has been set.
max	Sets speed to maximum speed. Will not appear when a password has been set.
set	Sets speed to the programmed value.

Pressing **menu** will enter Test Function Setup. If a password has been programmed, the display will prompt the following:

```
PASSWORD      0 0 0 0
ESC  -  +  ENTR
```

The password is a four digit number. Press **+** or **-** to increment or decrement the number. Once the complete password has been entered, press **ENTR**. If correct, the display will enter the Test Function Setup menu. If the password is incorrect, the display flashes "INCORRECT PASSWORD", and then reverts to Operating Mode.

5.3 FollowMe® mode

Crosshead movement responds to manually pushing or pulling on the force gauge shaft or load cell. Increasing force produces greater speeds. Ideal for quick positioning during sample loading and unloading. To arm **FollowMe®** mode, press the **FollowMe®** key. The display appears as follows:

SPEED :	0 . 0 0
FollowMe Active	



CAUTION!

Exercise extreme caution when handling low capacity force gauges or load cells, as overload can occur.

If no force is detected for 5 seconds after pressing the **FollowMe®** key, the function becomes inactive, and the display flashes "FOLLOWME OFF".

If the FollowMe® function has not been enabled in **Test Function Setup**, pressing the key will not arm the function. The display will flash "NOT ENABLED".

If the FollowMe® function has not been installed in the test stand, pressing the key will not arm the function. The display will flash "NOT INSTALLED".

5.4 Basic mode

The crosshead moves upward when **UP** is pressed, and downward when **DOWN** is pressed. When the crosshead is in motion, an LED indicator on the button pushed will be illuminated. The **KEYS** setting controls how crosshead movement responds to the push of either of the directional buttons. The three settings are:

1. **Maintained**

The crosshead will move continuously once the button has been pressed. Subsequently pressing STOP will stop crosshead motion.

2. **Momentary**

The crosshead will move only if the button is pressed and held. Releasing the button will stop movement immediately.

3. **Auto (default)**

Holding down the button for more than 0.5 seconds will enter Momentary mode, at which time an audible indicator will sound and the LED indicator on the button pushed will be illuminated. A short tap on the button will operate the test stand in Maintained mode. Pressing STOP during Maintained mode will stop crosshead motion. To resume the test, press UP or DOWN again.

Pressing **EMERGENCY STOP** will immediately stop crosshead motion in any mode. To release, twist the button clockwise until it assumes its original position. To resume the test, press either directional button for two seconds.

Crosshead movement will take place until a limit has been reached. If the crosshead has stopped at a soft limit, the limit condition may be overridden by pressing and holding either directional button for two seconds.

5.4.1 Travel indication

If installed, the position is displayed in the upper left corner of the display. The unit of measurement is dictated by the **UNITS** function. To zero the value, press the **Zero Travel** key. The position will be retained during power cycles.

5.4.2 Limit switch operation

Limit switches allow the operator to set a location along the column at which point the crosshead will stop moving. Adjust their positions by loosening the thumb screws, repositioning, and re-tightening the thumb screws, as illustrated below:

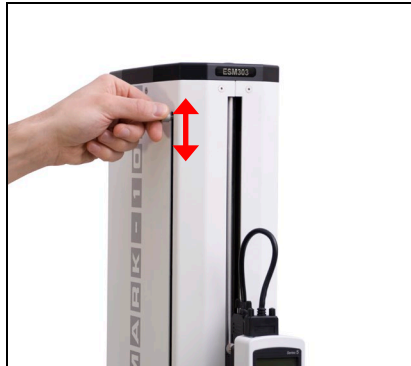

ESM303



ESM303H

5.4.3 Overload protection

The available interface cable is required for overload protection of a Mark-10 force gauge or load cell. If overload protection is installed and enabled, the crosshead will stop when the programmed percentage of full scale of the instrument has been reached.

When overload protection is installed, if the cable is disconnected, and/or if the instrument is powered off, an error message will appear. Plug in the cable and/or turn on the instrument to clear the message.

Note:

When the crosshead is moving in the tension direction, only the tension overload setting is active. When the crosshead is moving in the compression direction, only the compression overload setting is active.

5.5 Auto return mode

In this mode the crosshead moves at the set speed to whichever limit it encounters first and stops. Then, the crosshead returns at maximum speed to the opposite limit, whichever occurs first, and stops. Press either directional button to initiate an Auto Return sequence.

The crosshead can be stopped at any time during an Auto Return sequence by pressing **STOP**. To resume the test, press either directional button.

Note:

If the crosshead has stopped at a soft limit, the limit condition may be overridden by pressing and holding either directional button for two seconds.

5.6 Cycling mode

This mode cycles the crosshead between limits, whichever occurs first. One cycle consists of the following steps:

1. Crosshead moves to a limit at the specified speed.
2. Crosshead stops for the specified amount of dwell time.
3. Crosshead reverses direction, returns to the other limit at the specified speed, and stops for the specified amount of dwell time.

A cycling sequence can be initiated from any position and can start in either direction. To initiate a cycle sequence, press either directional button. During a cycle sequence, a counter will be displayed, indicating the number of cycles remaining, as shown below:

```
CYCLES      0 0 0 2 4
menu min max SET
```

As in Basic Mode, the **min**, **max**, and **set** soft keys are active during crosshead movement.

When the cycling sequence and the crosshead has stopped at a *soft limit*, the limit condition may be overridden by pressing and holding either directional button.

5.6.1 Dwell time

Dwell time is the amount of time, in seconds, for which the crosshead stops at a limit during a cycle sequence. When the crosshead has reached a limit, a counter will be displayed, shown as follows:

```
DWELL :      0 0 0 1 . 5
menu min max SET
```

If the dwell settings are set to 0, the crosshead will immediately reverse direction upon reaching the corresponding limit, and no counter will be displayed.

The cycle sequence may be interrupted before it has been completed by pressing **STOP**. A soft key labeled **RESET** will appear as follows:

```
CYCLES :      0 0 0 2 4
                RESET
```

At this point, there are two options:

1. **Cancel the cycle sequence:**
Press **RESET** to stop and reset the cycle sequence. The cycle counter will revert to the number of cycles originally programmed.
2. **Resume the cycle sequence:**
Press either directional button to resume.

Once the sequence has been completed, the screen will revert to the number of cycles programmed originally. To begin another cycle test, press either directional button.

Travel indication and limit switch operation is the same as in Basic Mode.

5.7 Preload mode

In this mode, the crosshead moves at the set speed (or no greater than 10 in/min [250 mm/min]) until the programmed preload value has been reached. If moving in the tension direction, a tension preload is required. If moving in the compression direction, a compression preload is required. When the preload is reached, the sequence of events programmed in the **Preload** function occurs. If the *ZERO, GO* setting is selected, and if the set speed is greater than 10 in/min [250 mm/min], the crosshead speed will revert to this setting after the travel indicator is zeroed.

Note 1:

Before the start of a preload sequence, the crosshead must be positioned at either of the **physical** limit switches.

Note 2:

Preload and **Load Holding** cannot be enabled simultaneously.

5.8 Load holding mode

In this mode, the crosshead moves until the set point value programmed in the force gauge or indicator is reached. The crosshead position dynamically adjusts to maintain a programmed force. The force gauge or load cell's capacity should be as close as possible to the intended load, for best performance.

In the instrument, **both** set points must be set. The upper set point refers to a force limit in the tension direction. The lower set point refers to a force limit in the compression direction. The opposite set point must be set to any value in the **opposite** measuring direction. For example, for a test requiring load holding at 10 lbf of compression force, set the upper set point to 30 lbf tension (as an example), and the lower set point to 10 lbf compression.

If the **CYCLING** option has been enabled, load holding will be active for the period of time as defined in the **Dwell Time** settings. If **CYCLING** has not been enabled, load holding will continue indefinitely.

Note 1:

Before the start of a load holding sequence, the crosshead must be positioned at either of the **physical** limit switches.

Note 2:

Preload and **Load Holding** cannot be enabled simultaneously.

5.8.1 Adjusting speed for sample stiffness variations

An appropriate speed should be chosen for a given sample. Fine tuning may be necessary to ensure optimal crosshead dynamic behavior. Stiff samples require a lower test speed; softer samples can be tested at higher speeds. If the speed of approach is too high for a given sample stiffness, the crosshead may overshoot the set point value, requiring an adjustment sequence where the crosshead reverses, then moves again in the original direction multiple times before settling at the set point value. A high enough speed may cause this correction cycle to repeat indefinitely.

For softer samples the amplitude of oscillation will be smaller, but could still be present for the duration of the load holding period. This is typical for samples which may relax, such as rubber, foam, etc. Lowering the test speed will reduce the oscillation.

For minimally relaxing materials such as metal springs, the oscillation should stop shortly after the holding force is reached.

Load holding may be interrupted at any time by pressing **STOP**.

5.9 Break detection mode

In this mode, the crosshead will stop when a sample break has occurred. This action occurs when the force decreases to a specified percentage of peak, as illustrated below:

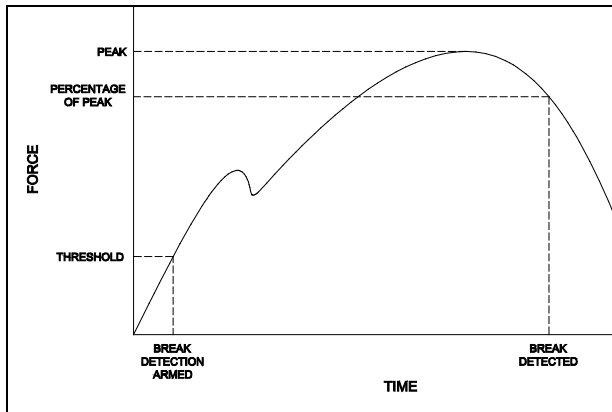

If enabled, an auto-return sequence or single-cycle sequence may follow break detection.

6 COMMUNICATION

6.1 Setup

The ESM303 can transmit force and travel (optional) data to a PC. The following settings are required for proper functioning of all test stand functions and data output:

Force gauge / indicator (Series 5 / 7 only):

- RS-232 communication
- 115,200 baud rate
- Auto Output: disabled

ESM303 test stand menu:

- CONTROL: CONSOLE (this menu is only shown if the **PC Control** function is installed; **PC Control** is not required for data output)
- STOP & PAR (stop bits and parity): 8-1n (8 data bits, one stop bit, no parity)

Connection cables:

- Gauge / indicator to test stand: Part no. AC1114 or AC1115
- Test stand to PC (USB): Part no. AC1107

If not using Mark-10 data collection software, ensure that the software's communication settings match. A number of data collection commands are available, highlighted in **blue** in the following section.

6.2 PC Control Mode

Motion control and data collection functions may be sent by an external device via user-developed applications. A list of supported ASCII commands is provided below.

NOTE: All commands are a fixed format and do not require a terminating character. Responses from request commands are terminated with a CR-LF pair. (CR = 0xD, LF = 0xA)

PC Control is required for all commands, except those highlighted in **blue**.

Command	Description	Example
a	Request speed	
b	Set travel unit to inches	
c	Enter cycle mode	
d	Move crosshead down or left	
e	Set speed	
	Inch format: eXX.XX Two leading zeroes and two decimal places required.	e02.85 = 2.85 in/min
	Millimeter format: eXXXX.X Four leading zeroes and one decimal place required.	e0200.3 = 200.3 mm/min
f	Set cycles. Format: fXXXX (leading zeroes required)	f0500 = 500 cycles
g	Set lower travel limit	
	Inch format: g-XX.XXX Negative sign (if applicable), two leading zeroes, and three decimal places required.	g-00.550 = -0.55 in g01.258 = 1.258 in
	Millimeter format: g-XXX.XX Negative sign (if applicable), three leading zeroes, and two decimal places required.	g-007.52 = -7.52 mm g010.70 = 10.7 mm
h	Set upper travel limit	
	Inch format: h-XX.XXX Negative sign (if applicable), two leading zeroes, and three decimal places required.	h-00.550 = -0.55 in h01.258 = 1.258 in
	Millimeter format: h-XXX.XX Negative sign (if applicable), three leading zeroes, and two decimal places required.	h-007.52 = -7.52 mm h010.70 = 10.7 mm
i	Set travel unit to millimeters	
j	Set crosshead speed to maximum speed	
k	Set crosshead speed to minimum speed	
l	Enter travel limit mode ¹	
m	Enter manual mode	
n	Transmit travel and force readings	
o	Set crosshead speed to programmed speed	
p	Request stand status ²	
q	Request number of cycles completed	
r	Request number of cycles set	
s	Stop crosshead	
t	Reset cycle counter to zero	
u	Move crosshead up or right	
v	Request upper travel limit	
w	Request lower travel limit	
x	Request travel value	
z	Reset position to zero	

1. If travel limit mode is disabled, the crosshead will only stop at physical limit switches. Force and distance limits are ignored.
2. The transmission of ASCII "p" will return the stand status. The following are the return codes and their definitions (upper case):

	Response	Description
Crosshead status	U	Crosshead moving up
	D	Crosshead moving down
	S	Crosshead stopped
Operating mode	C	Cycle mode
	L	Limit mode
	M	Manual mode
Limit switch status	UL	Crosshead at upper limit
	DL	Crosshead at lower limit

6.2.1 Force gauge / indicator commands

Mark-10 force gauge and indicator commands are compatible with the ESM303. To open this channel of communication, use a forward slash “ / ” (no quotations), followed by the commands, followed by a back slash “ \ ” to close the channel. Refer to the instrument's user's guide for a complete list of commands.

The following gauge / indicator commands (upper case) do not require slashes:

Command	Description
A	Displays current unit
F	Toggles between Normal and Data Collect modes
P	Steps through Normal mode, Tension Peak mode, and Compression Peak mode
R	Zeroes the instrument (zeroes all modes)
S	Sends current mode (Normal, Tension Peak, Compression Peak, or Data Collect)
U	Steps through units
X or ?	Sends currently displayed reading
Y	Enables RS-232 output and sends continuous data stream when in Data Collect mode
Z	Zeroes the peak values

The ESM303 is compatible with legacy Nexygen™ TCD software (not available from Mark-10), which also utilizes the above commands. Baud rate, stop bits and parity must be configured in the stand to correspond with the PC software's settings.

While in PC control, if any functions are changed on the front panel, these settings will be ignored, except if Auto Return or Cycling are turned on. If so, PC control will be turned off automatically.

7 FUNCTION ACTIVATION

This menu displays the list of available functions and indicates which ones are installed, indicated by "ON" or "OFF". Those that are not installed can be installed in the field.

7.1 Accessing the Function Activation menu

While in Operating Mode, press and hold **STOP**, then press **menu** simultaneously, and release both buttons. The display will appear as follows:

```
CYCLING :      OFF
ESC  <-  ->  ENTR
```

Label	Description
< -	Scrolls to the previous function
- >	Scrolls to the next function
ENTR	Selects the function
ESC	Exits Function Activation menu

7.2 Activating functions

Functions not originally purchased can be activated with an *authorization code*. To activate the function, scroll through the menu until the desired function is displayed, then press **ENTR**. If the function is already installed (indicated by "ON"), pressing **ENTR** has no effect. If the function is off, pressing **ENTR** will generate a *request code* on the display, as shown below:

```
CYCLING:  0139027
ESC      +  ->  ENTR
```

The *request code* must be supplied to Mark-10 or a distributor, who will then provide a corresponding *authorization code* to activate the function.

The process for entering the *authorization code* is as follows:

1. The first digit of the *request code* will be flashing. Press **+** to increment the digit. Pressing **+** when the number 9 is displayed will cycle to 0.
2. Press **->** to advance to subsequent digits, and change them in the same manner.
3. Press **ENTR** when complete. If an incorrect code is entered, the display will revert to the Function Activation menu, without installing the function. If this happens the above process must be repeated.

The Function Activation menu also includes a utility for disabling the password. Scroll through the functions until the following is displayed:

```
DISABLE PASSWORD
ESC  <-  ->  ENTR
```

Press **ENTR** to generate the *request code*, then follow the *authorization code* procedure indicated above.

7.3 Demo mode

All ESM303 test stands are shipped in *Demo Mode*, which provides full functionality of all available functions for an evaluation period of 160 operating hours. When this period has expired, an additional 160 hours may be added via the *authorization code* procedure indicated above.

8 AC1086-1 SHIELD INSTALLATION



The optional AC1086-1 shield can protect the operator against the dangers of airborne debris resulting from compression and tension force testing. Follow these assembly and usage instructions:

1. The shield is shipped fully assembled. Remove it from the box and remove the packaging.
2. Position the mounting bracket on top of the ESM303 column, aligning the thru holes with the corresponding threaded holes at the top of the ESM303 test stand column. Fasten the six provided socket head screws, as shown below:



3. Plug the interlock cable into the corresponding connector in the rear of the test stand column, labeled "AUX. LIMITS", as shown in the **Connections and Outputs** section.
4. Route all cables, such as the test stand power cable and control panel cable, underneath the shield, as shown below. **Do not** route cables through the cutout in the sheet metal cover. Doing so can result in damage to the cables while the door is rotating past this area. The cutout is provided only for hand access to the connector panel.

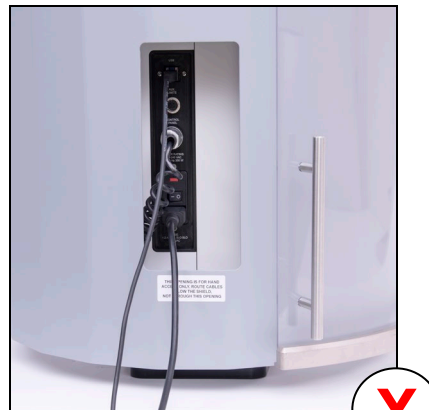

5. The door may be opened in the clockwise or counter-clockwise direction. Magnetic detents are provided for the closed position. If the interlock cable is plugged in, the ESM303's control panel will display the message "SHIELD OPEN" when the door is open. The ESM303 cannot be operated in this state, however, the FollowMe® function may be used to adjust the crosshead position for sample loading.

Note that the following minimum ESM303 firmware versions are required: Front: 2.02.08 / Main: 2.02.07. With prior versions, the FollowMe® function will not operate while the door is open. Contact Mark-10 for upgrade instructions.

9 AF009 TRAVEL INDICATION OPTION RETROFIT

Retrofitting an ESM303 test stand with the AF009 travel indication option requires hardware installation and entering an activation code. The instructions below reference Model ESM303, however, the process is similar with the ESM303H.

9.1 Hardware installation

1. Power off the test stand and disconnect all cables.
2. Remove the upper and lower limit switch thumb screws, then remove the left sheet metal cover. The limit switches and screws are identified in the image below:



3. The electronics support plate contains most of the test stand's electronics, and must be removed to access the required area. First, remove the 6 screws, identified in the image below. **Do not** pull the plate away from the column yet, as additional steps are required for removal.

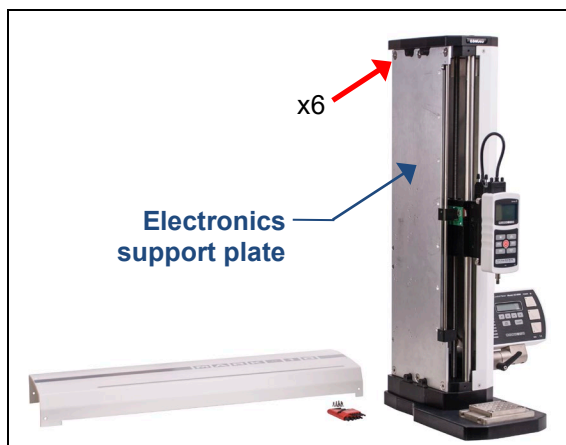

- Carefully tilt the plate back slightly, then disconnect the 3 connectors, as identified in the images below. Then, remove the plate.

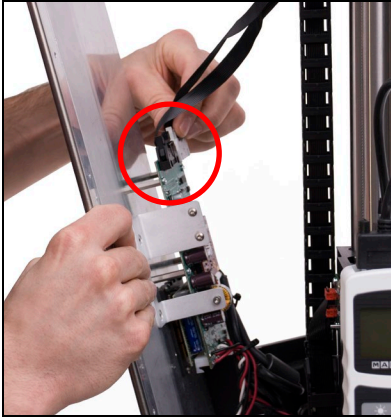

- Note the components below. Then attach the encoder strip to the plate with 7 screws.

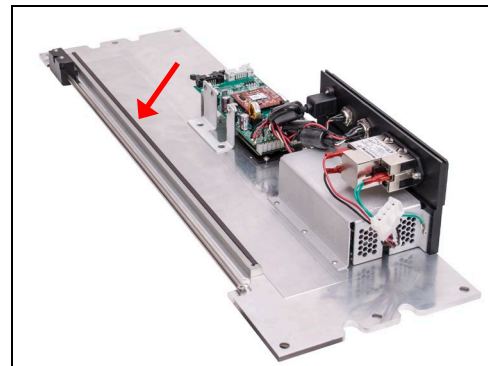
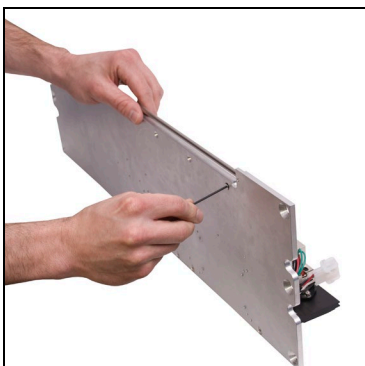
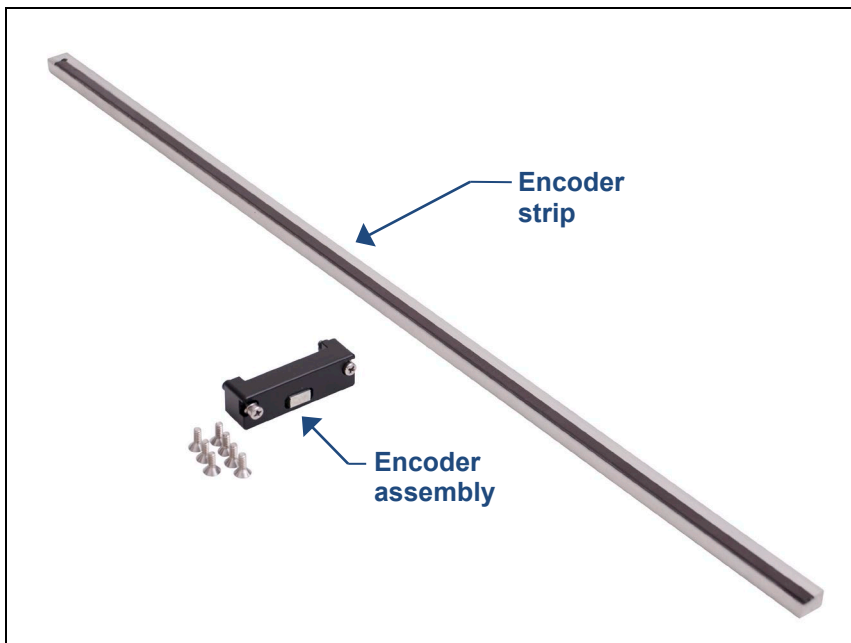

6. Install the encoder assembly to the crosshead with 2 screws, as shown in the image below:



7. Re-install all hardware and components in reverse order. Be sure to position the upper limit switch above the crosshead and the lower limit switch below the crosshead before installing to the electronics support plate.

9.2 Entering the *activation code*

Access the Function Activation menu and locate the function labeled “TRAVEL”. Obtain the *request code*, and enter the *activation code*, a process described in the **Function Activation** section. After inputting the *activation code*, cycle the crosshead up and down to ensure that the position indicator is incrementing and decrementing properly.

10 SEPARATING THE COLUMN FROM THE BASE / COLUMN EXTENSION INSTALLATION

The column may be separated from the base to accommodate alternative mounting arrangements, for considerations such as safety, increased sample clearance, integration into existing equipment, etc. The instructions below reference Model ESM303, however, the process is similar with the ESM303H.

10.1 Removing the base from the column

To remove the base, follow these instructions:

1. Power off the test stand and disconnect the power cable.
2. Lay the test stand on its side and remove the 6 screws from the underside of the base. Carefully remove the base from the frame. Refer to the image below.

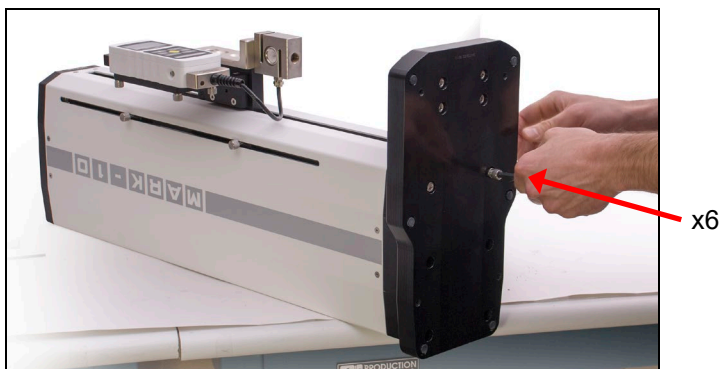

10.2 Retrofitting a Mark-10 single column extension (optional)

If a single column extension is ordered upfront, it is pre-installed at the factory and shipped assembled. It may also be retrofitted in the field. Follow these instructions:

1. Remove the two sheet metal covers from the column extensions by loosening the 16 screws, as identified in the images below.

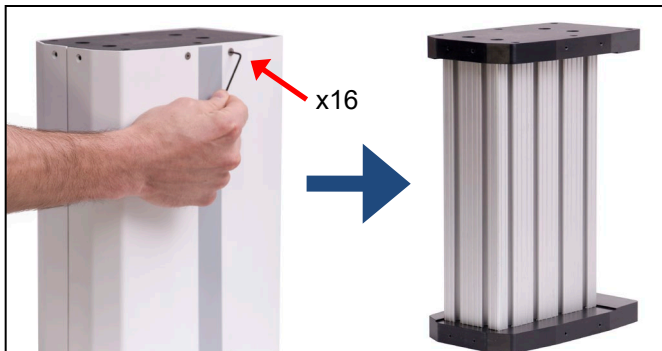

2. Using the 6 screws removed from the test stand base, reinstall the base onto the lower flange of the column extension, as shown in the image below:

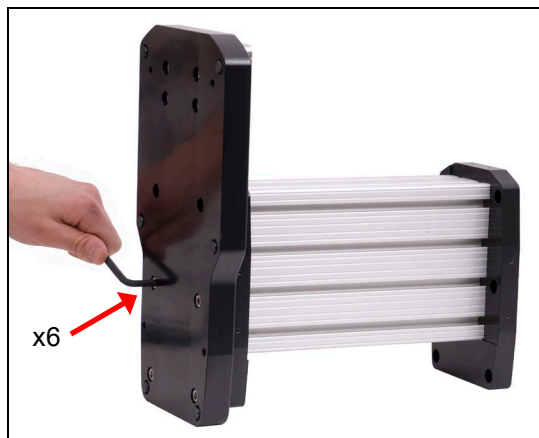

3. Attach the top flange to the bottom of the test stand column utilizing the 6 supplied screws, as shown in the image below:



4. Position the test stand vertically and reinstall the sheet metal covers, as shown below:

**CAUTION!**

Vertical column extensions present an increased tipping hazard. It is strongly recommended that the base be fastened to a workbench. Holes are supplied on the underside of the base. Refer to the dimensional drawing for hole locations.

10.3 Installing a double column extension (optional, Model ESM303 only)

The optional double column extension is shipped fully assembled. To mount the test stand frame to the assembly, locate the 6 thru holes, match them up to the corresponding threaded holes on the underside of the frame, and install the screws. Refer to the image below:



11 MAINTENANCE AND SERVICE

The ESM303 should be operated in a dry and clean area. Under these circumstances only a few periodic maintenance operations are required:

11.1 Ball screw lubrication – at least twice per year

Periodic lubrication improves performance and increases the longevity of test stand components. On average, lubrication is recommended twice per year. However, the frequency should increase if the stand is operated in adverse environmental conditions, including airborne dust, temperature and humidity extremes, and other factors. Frequent test stand usage also necessitates more frequent lubrication.

Follow these instructions for proper ball screw lubrication:

1. Power off the test stand and disconnect all cables.
2. Remove the left sheet metal and electronics support plate as described in previous sections.
3. Using a brush, apply a small amount of general purpose bearing grease to the screw, as shown in the image below:

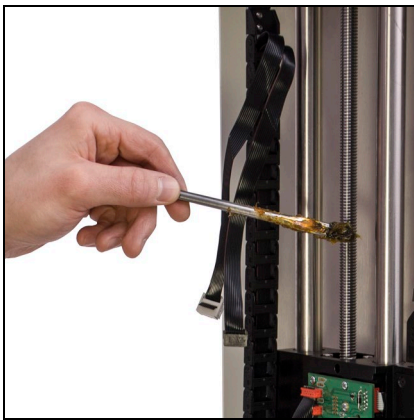

4. Cycle the crosshead several times until the newly applied grease has been spread evenly over the length of the screw.
5. Re-install the hardware. Be sure to position the upper limit switch above the crosshead and the lower limit switch below the crosshead before installing to the electronics support plate.

11.2 Check for loosened grips and attachments – daily

Check to ensure that the grips attached to the force gauge and base plate are firmly secured. Looseness could result in a potentially hazardous situation.

11.3 Check for loosened components – once per month

1. Remove the test sample from the test stand.
2. Attempt to loosen subcomponents of the test stand (ex. fasteners, brackets, etc). All components should be firmly attached. If any looseness is detected, stop using the test stand and contact Mark-10 or a distributor for instructions.

11.4 Removing and replacing the Electronics Support Plate

As described earlier, most electronics are mounted to a support plate located along the left side of the column. It is designed for quick removal and replacement in the event of service or repair. If instructed by Mark-10 or a distributor to remove and/or replace this plate, follow the instructions outlined in the **Installing the Travel Indication Option** section.

12 TROUBLESHOOTING

1. The ESM303 displays several error messages, as follows:

Error Message	Description
CHECK GAUGE	The force gauge or indicator is powered off, not in the operating mode, or not connected to the stand. Message appears when overload protection is turned on.
GAUGE COMM ERROR	The stand is attempting to move the crosshead up or down, but it cannot establish communication with the force gauge or indicator. The communication settings in the instrument are not correct or the instrument is not in its normal operating mode.
GAUGE OVERLOAD	The programmed overload percentage of the force gauge's or indicator's full scale has been reached. Immediately reduce the force or adjust the overload settings.
M5/M7 V2.0+ REQD	A Series 5 or 7 force gauge or indicator with firmware version 2.0 or later is required for proper operation of the selected functions.

To clear any of the above errors, press **STOP**. The amber indicator in the **STOP** button will be blinking while the error message is displayed.

2. The crosshead will move only in one direction, or not at all.

Possible causes:

1. Ensure that both limit switch thumb screws are installed, and positioned to allow crosshead motion.
2. Ensure all cables are plugged in properly, as described in **Setup and Safety** section.
3. Ensure that the force value has not exceeded the overload limits configured in the stand.
4. Ensure that instrument's set points have been configured properly. Both set points must be enabled, regardless of test direction, with upper limit in the tension direction, and lower limit in the compression direction.

3. Certain menu items are no longer displayed.

All test stand functions are temporarily enabled for 160 hours of operation in *Demo Mode*. When demo mode has expired, any functions (and their associated menus) not originally purchased will no longer be displayed.

4. FollowMe® does not work while the shield is installed and/or an interlock cable is plugged in.

The following minimum test stand firmware versions are required:

Front: 2.02.07

Main: 2.02.08

13 SPECIFICATIONS

Load capacity:	< 24 in [610 mm]/min: 300 lbF [1.5 kN] > 24 in [610 mm]/min: 200 lbF [1 kN]
Standard speed range:	0.5 – 13 in/min [13 – 330 mm/min]
Optional speed range:	0.02 – 45 in/min [0.5 – 1,100 mm/min]
Maximum travel:	18.0 in [457 mm]
Speed setting accuracy:	±0.2%
Speed variation with load:	±0% [Stepper motor driven]
Travel accuracy:	±0.002 in. per 10 in. [±0.05 mm per 250 mm]
Travel resolution:	0.001 in [0.02 mm]
Limit switch repeatability:	0.001 in [0.03 mm]
Power:	Universal input 80-240 VAC, 50/60 Hz, 60W
Fuse type:	1.2 A, 250V, 3AG, SLO BLO
Weight (without options):	ESM303: 56.5 lb (25.6 kg) ESM303H: 62.5 lb (28.4 kg)
Environmental Conditions:	40 - 100°F [5 - 40°C], max. 93% humidity, non-condensing

14.2 ESM303H

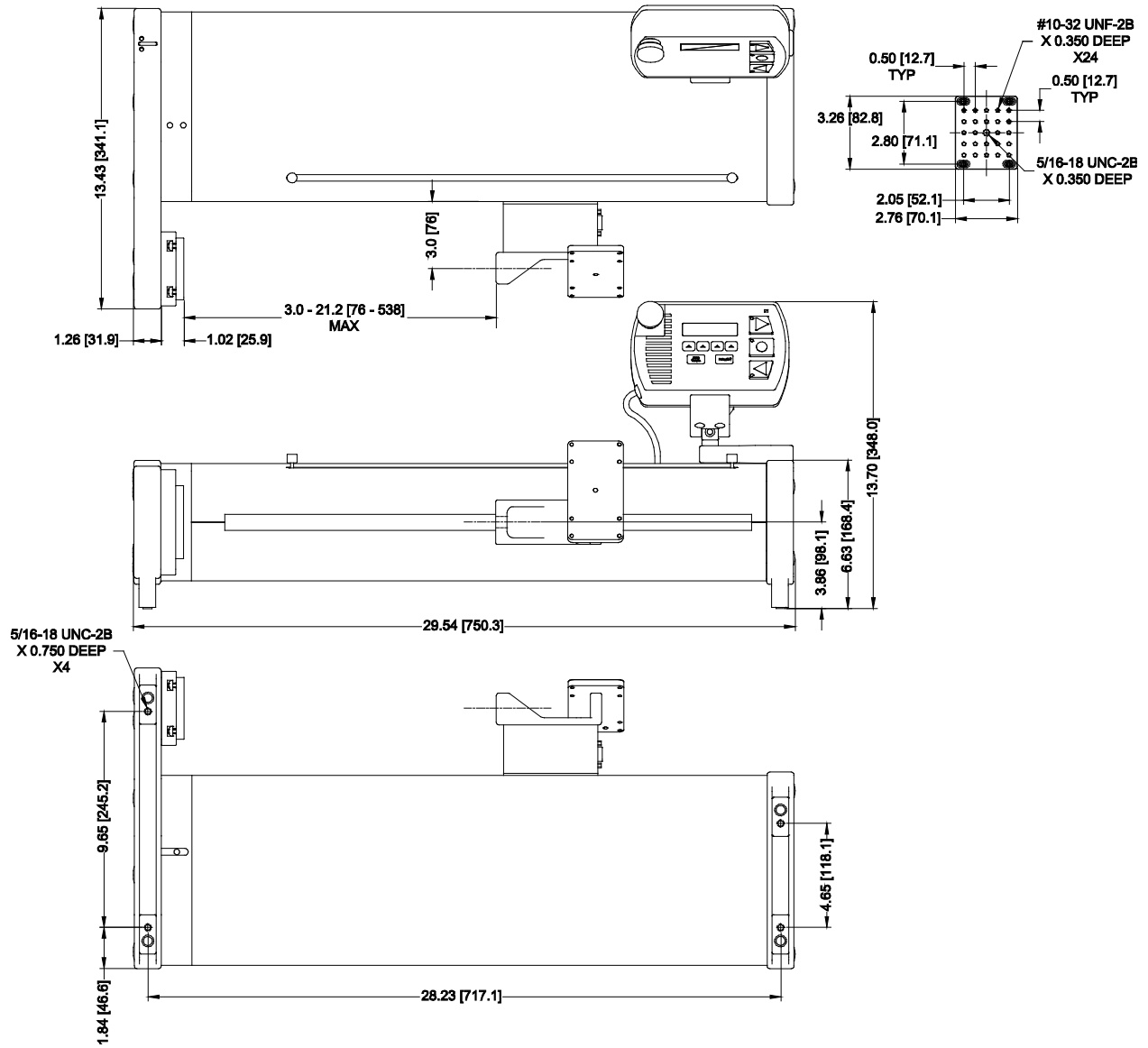

14.3 ESM303-002-1 / -2 / -3 Double Column Extensions (optional)

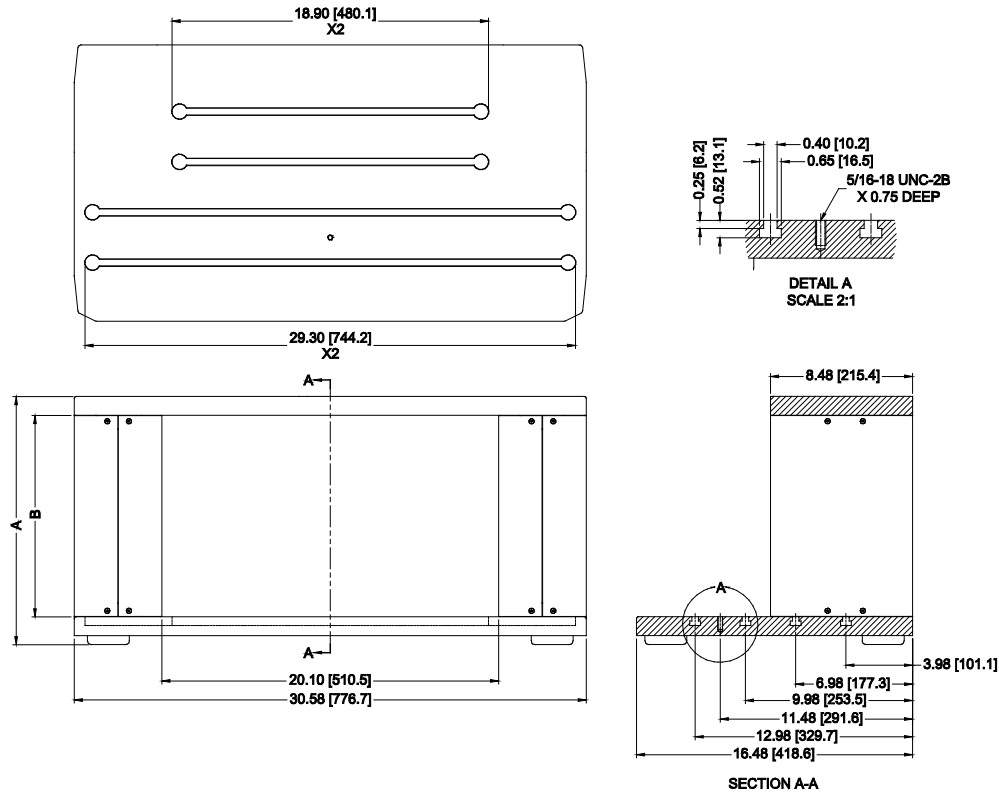

	A	B
ESM303-002-1	8.79 [223.3]	6.00 [152.4]
ESM303-002-2	14.79 [375.7]	12.00 [304.8]
ESM303-002-3	26.79 [680.5]	24.00 [609.6]

14.4 AC1086-1 Shield (optional)

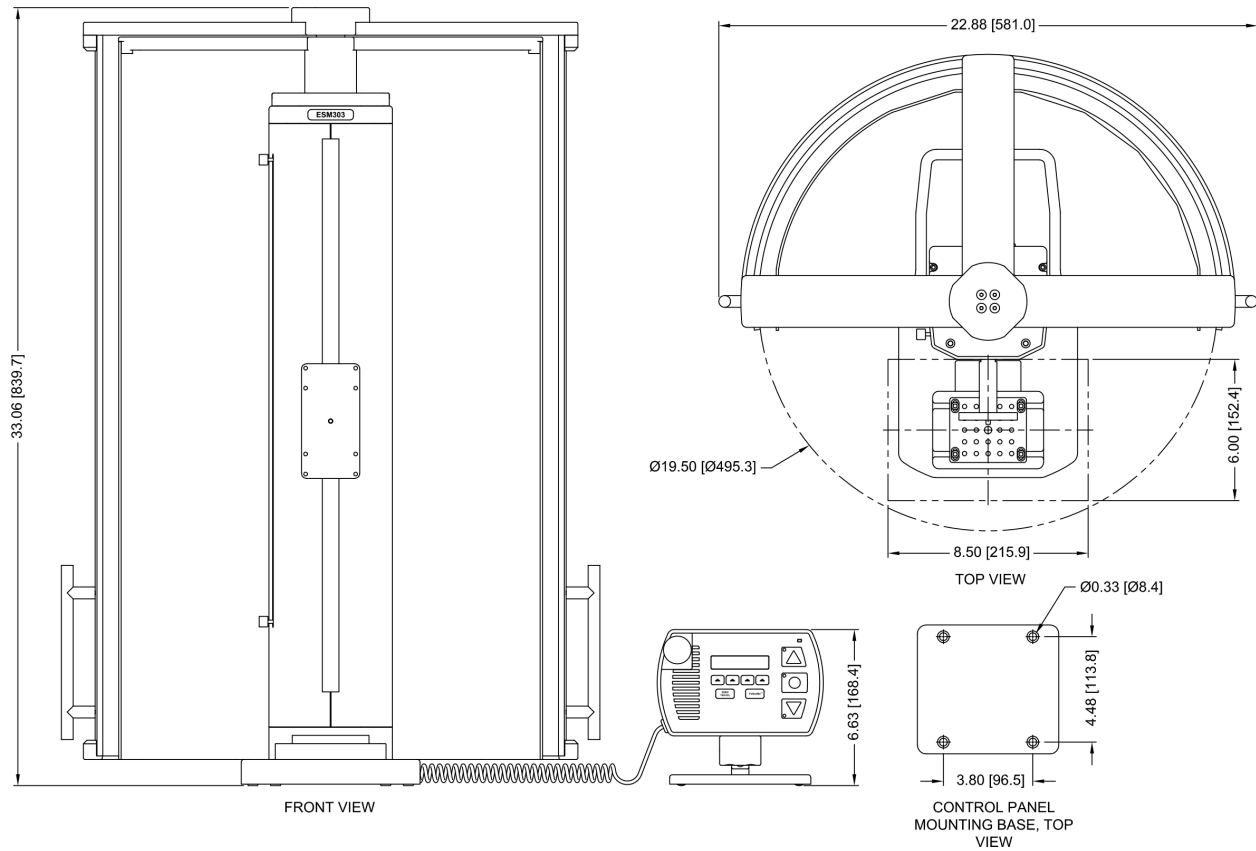



Mark-10 Corporation has been an innovator in the force and torque measurement fields since 1979. We strive to achieve 100% customer satisfaction through excellence in product design, manufacturing and customer support. In addition to our standard line of products we can provide modifications and custom designs for OEM applications. Our engineering team is eager to satisfy any special requirements. Please contact us for further information or suggestions for improvement.



Force and torque measurement engineered better

Mark-10 Corporation

11 Dixon Avenue
Copiague, NY 11726 USA
888-MARK-TEN
Tel: 631-842-9200
Fax: 631-842-9201
www.mark-10.com
info@mark-10.com