

32-1135 REV 2



Series R50 smart sensors measure bi-directional torque for a wide variety of applications across virtually all industries. Contain a Jacobs chuck for up to 0.5 in [12.7 mm] diameter samples, bits, or fixtures. The sensors can be used as hand held devices, or mounted to a test stand. Capacities available from 10 ozFin to 100 lbFin [7 to 1150 Ncm]. Compatible with Mark-10 indicators (sold separately) through unique Plug & Test™ technology.

Specifications

Accuracy:	±0.35% of full scale + indicator
Chuck opening range:	MR50-10Z - MR50-50Z: 0.062 - 0.375 in [1.6 - 9.5 mm] MR50-12 - MR50-100: 0.078 - 0.5 in [2.0 - 12.7 mm]
Safe Overload:	MR50-10Z - MR50-50Z: 300% of full scale MR50-12 - MR50-100: 150% of full scale
Weight:	From 1.4 lb [0.6 kg]

Dimensions in [mm]

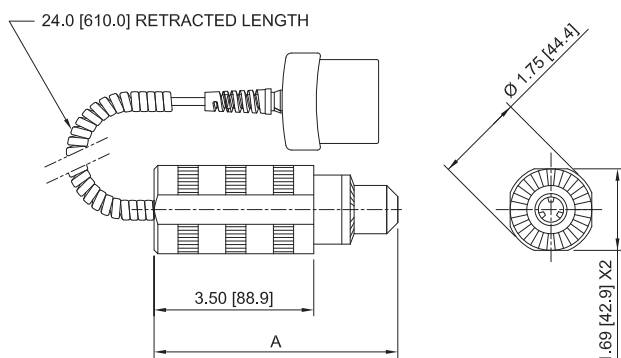

Capacity x Resolution

Model No.	With Models 7i & 5i indicators								With Model 3i indicator			
	lbFin	ozFin	lbFft	gFcm	kgFmm	Nmm	Ncm	Nm	lbFin	ozFin	kgFmm	Ncm
MR50-10Z	-	10 x 0.005	-	700 x 0.5	7 x 0.005	70 x 0.05	7 x 0.005	-	-	10 x 0.01	7 x 0.005	7 x 0.005
MR50-20Z	-	20 x 0.01	-	1400 x 1	14 x 0.01	140 x 0.1	14 x 0.01	-	-	20 x 0.02	14 x 0.01	14 x 0.01
MR50-50Z	-	50 x 0.02	-	3600 x 2	36 x 0.02	350 x 0.2	35 x 0.02	-	-	50 x 0.05	36 x 0.05	35 x 0.05
MR50-12	12 x 0.005	192 x 0.1	1 x 0.0005	-	-	-	135 x 0.1	1.35 x 0.001	12 x 0.01	192 x 0.2	-	135 x 0.1
MR50-50	50 x 0.02	800 x 0.5	4 x 0.002	-	-	-	570 x 0.5	5.7 x 0.005	50 x 0.05	800 x 1	-	570 x 0.5
MR50-100	100 x 0.05	1600 x 1	8 x 0.005	-	-	-	1150 x 0.5	11.5 x 0.005	100 x 0.1	1600 x 2	-	1150 x 1



< Unique Plug & Test™ technology allows for interchangeable sensors to be used with a Mark-10 indicator. All calibration and configuration data is saved in the smart connector.



< The Plug & Test™ connector locks into the receptacle in the indicator when fully inserted. Dual buttons on the indicator housing release the connector for easy removal. Gold plated spring contacts ensure long lasting and reliable connection.

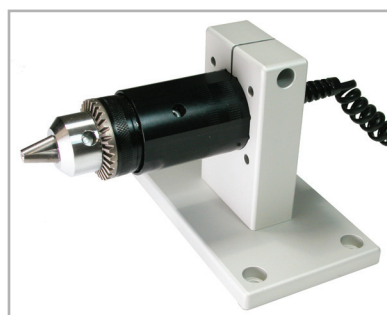

^ Optional AC1007 tabletop mounting kit may be used to hold the sensor in place.

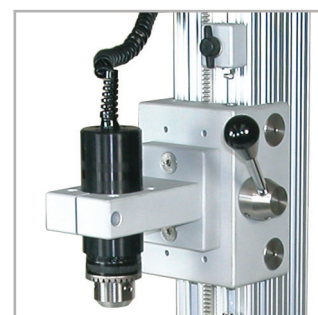

^ A Series R50 torque sensor is shown mounted to a model TSTM motorized torque test stand. The sensor fits into the stand without the need for additional adapters.

Model No.	A
MR50-10Z - MR50-50Z	4.82 [122.4]
MR50-12 - MR50-100	5.19 [131.8]

Optional Items

AC1007	Mounting kit, Series R50, table top
--------	-------------------------------------