

Series **E**

ERGONOMICS FORCE GAUGES

User's Guide

MARK-10®

Thank you...



Thank you for purchasing a Mark-10 Series E ergonomics force gauge, designed for tension and compression testing applications with a range of interchangeable accessories.

With proper usage, we are confident that you will get many years of great service with this product. Mark-10 force gauges are ruggedly built for many years of service in laboratory and industrial environments.

This User's Guide provides setup, safety, and operation instructions. Dimensions and specifications are also provided. For additional information or answers to your questions, please do not hesitate to contact us. Our technical support and engineering teams are eager to assist you.

Before use, each person who is to use the Series E force gauge should be fully trained in appropriate operation and safety procedures.

TABLE OF CONTENTS

OVERVIEW	2
POWER	4
SETUP	5
HOME SCREEN AND CONTROLS	7
SET POINTS	9
OPERATING MODES	10
DATA MEMORY AND STATISTICS	13
COMMUNICATIONS AND OUTPUTS	15
CALIBRATION	17
PASSWORDS	22
OTHER SETTINGS	23

1 OVERVIEW

1.1 List of included items – Force Gauge Only – ME-100, ME-200, ME-500

Qty.	Part No.	Description
1	12-1049	Carrying case
1	08-1022	AC adapter body with US, EU, UK, or AUS prong
1	AC1118	Battery (inside the gauge)
1	AC1111	USB cable
-		USB driver, MESUR® Lite software, MESUR®gauge evaluation software, User's Guide Download at: www.mark-10.com/resources

1.2 List of included items – Basic Kits – EKE-100-1, EKE-200-1, EKE-500-1

Qty.	Model No.	Description
1	ME-100 / ME-200 / ME-500	Force gauge
1	08-1022	AC adapter body with US, EU, UK, or AUS prong
1	AC1118	Battery (inside the gauge)
1	AC1111	USB cable
1	E1003	Padded attachment, rectangular
1	E1004	Padded attachment, curved
1	E1006	Hook
1	E1009	Double handle grip
1	E1000	Carrying case, small
-		USB driver, MESUR® Lite software, MESUR®gauge evaluation software, User's Guide Download at: www.mark-10.com/resources

1.3 List of included items – Advanced Kits – EKE-100-2, EKE-200-2, EKE-500-2

Qty.	Model No.	Description
1	ME-100 / ME-200 / ME-500	Force gauge
1	08-1022	AC adapter body with US, EU, UK, or AUS prong
1	AC1118	Battery (inside the gauge)
1	AC1111	USB cable
1	E1002	Padded attachment, square
1	E1003	Padded attachment, rectangular
1	E1004	Padded attachment, curved
1	E1005	Padded attachment, circular
1	E1006	Hook
1	E1007	Chain / hook assembly
1	E1008	Single handle grip
1	E1009	Double handle grip
1	E1010	Pistol grip
1	E1001	Carrying case, large
-		USB driver, MESUR® Lite software, MESUR®gauge evaluation software, User's Guide Download at: www.mark-10.com/resources

1.4 Safety / Proper Usage

Caution!

Note the force gauge's capacity before use and ensure that the capacity is not exceeded. Producing a force greater than 200% of the gauge's capacity can damage the internal load cell. An overload can occur whether the gauge is powered on or off.

The gauge is intended for use in muscle strength measurement, job task analysis, ergonomic assessment, and related applications. Do not use the gauge to engage any potentially flammable substances or products, items that can shatter in an unsafe manner, and any other components that can present an exceedingly hazardous situation when acted upon by a force.

The following safety checks and procedures should be performed before and during operation:

1. Never operate the gauge if there is any visible damage to the AC adapter or the gauge itself.
2. Ensure that the gauge is kept away from water or any other electrically conductive liquids at all times.
3. The gauge should be serviced by a trained technician only. AC power must be disconnected and the gauge must be powered off before the housing is opened.
4. Always consider the characteristics of the sample being tested before initiating a test. A risk assessment should be carried out beforehand to ensure that all safety measures have been addressed and implemented.
5. Wear eye and face protection when testing, especially when testing brittle samples that have the potential to shatter under force. Be aware of the dangers posed by potential energy that can accumulate in the sample during testing. Extra bodily protection should be worn if a destructive failure of a test sample is possible.
6. In certain applications, such as the testing of brittle samples that can shatter, or other applications that could lead to a hazardous situation, it is strongly recommended that a machine guarding system be employed to protect the operator and others in the vicinity from shards or debris.
7. When the gauge is not in use, ensure that the power is turned off.

2 POWER

The gauge is powered either by an 8.4V NiMH rechargeable battery or by an AC adapter. Since the batteries are subject to self discharge, it may be necessary to recharge the unit after a prolonged period of storage. Plug the accompanying charger into the AC outlet and insert the charger plug into the receptacle on the gauge (refer to the illustration below). The battery will fully charge in approximately 8 hours.

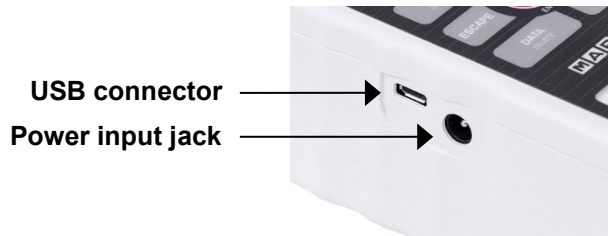





Caution!

Do not use chargers or batteries other than supplied or instrument damage may occur.

If the AC adapter is plugged in, an icon appears in the lower left corner of the display, as follows: 

If the AC adapter is not plugged in, battery power drainage is denoted in a five-step process:

Battery Life:	>75%	50 – 75%	25 – 50%	<25%	<2%
Indicator:					 (flashing)

At a critically low level, a message appears, “BATTERY VOLTAGE TOO LOW. POWERING OFF”. An audio tone will sound and the gauge will power off.

The gauge can be configured to automatically power off following a period of inactivity. Refer to the **Other Settings** section for details.

If battery replacement is necessary, it can be accessed by removing the battery cover in the rear of the housing with two screws, as shown below:



3 SETUP

3.1 Mechanical Setup

3.1.1 Mounting attachments to the gauge

Attachments are mounted to the gauge's receptacle via the Click-Lock™ mechanism. Line up the attachment with the receptacle, and press in until a click occurs. The attachment may be inserted in 90- or 180- degree orientations, as shown below:



To release the attachment, pull back on the lever in the rear of the housing, as shown below:



If the E1011 grip adapter (pictured below) is used, common grips and attachments may be mounted via the integrated 5/16-18F thread.



3.1.2 Mounting to a plate

The round steel insert with a hole in the back of the housing is provided to withstand the load during a test. A mating dowel pin should be used (see illustration below). Mark-10 mounting plates include a dowel pin and clearance holes for the four threaded holes located near the corners of the housing. These holes are designed to accommodate screws in order to hold the gauge in place. The screws must **not** be used for load bearing purposes. Failure to use a dowel pin properly can result in a hazardous situation.

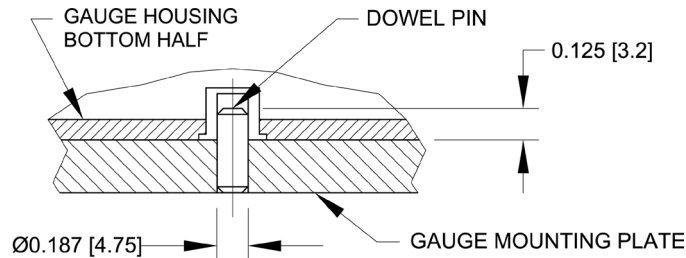

3.2 Installing the USB driver

If communicating via USB, install the USB driver available at: www.mark-10.com/resources

Caution!



Install the USB driver before physically connecting the gauge to a PC with the USB cable.

Further instructions for configuring and using the gauge's outputs are provided in the **Communications and Outputs** section.

4 HOME SCREEN AND CONTROLS

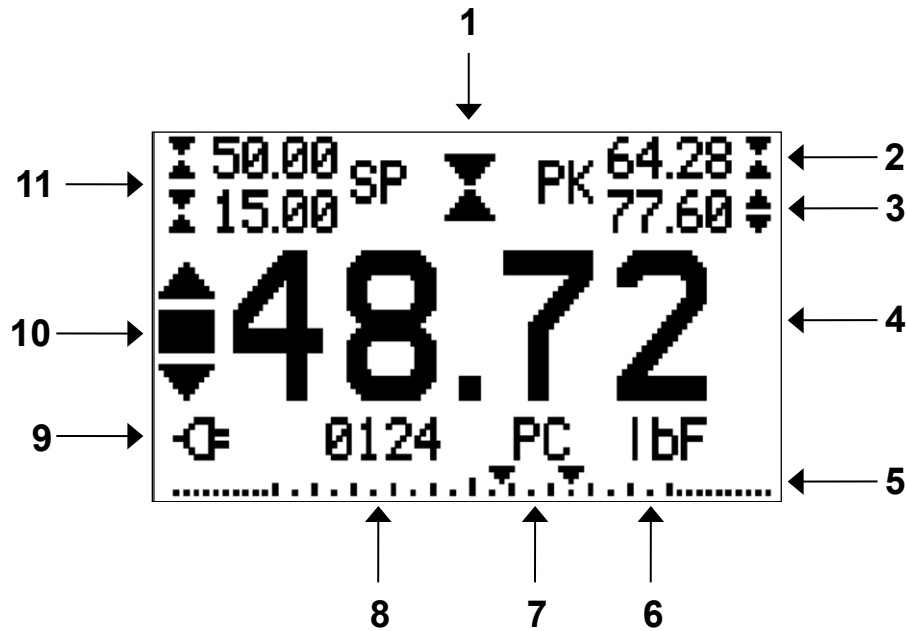
4.1 Home Screen



No.	Name	Description
1	Tension / compression indicator	<p>  - indicates a compression (push) direction  - indicates a tension (pull) direction These indicators are used throughout the display and menu. </p>
2	Compression Peak	The measured compression peak reading. This reading may be reset by pressing ZERO or by powering the gauge off and on.
3	Tension Peak	The measured tension peak. May be reset by pressing ZERO or by powering the gauge off and on.
4	Primary reading	The current displayed force reading.
5	Load bar	Analog indicator to help identify when an overload condition is imminent. The bar increases either to the right or to the left from the midpoint of the graph. Increasing to the right indicates compression load, increasing to the left indicates tension load. If set points are enabled, triangular markers are displayed for visual convenience. This indicator reflects the actual load, which may not correspond to the primary reading (depends on operating mode). The ZERO key does not reset the load bar. See Operating Modes section for details.
6	Units	The current unit of measurement. Abbreviations are as follows: lbF – Pound-force ozF – Ounce-force kgF – Kilogram-force N – Newton kN – Kilonewton
7	Mode	The current measurement mode. Abbreviations are as follows: RT – Real Time PC – Peak Compression PT – Peak Tension A – Average

		CAPT – Data Capture See Operating Modes section for details.
8	Number of stored data points	The number of stored data points in memory, up to 5,000. Displayed only if Memory Storage or Data Capture functions are used.
9	Battery / AC adapter indicator	Either the AC adapter icon or battery power icon will be shown, depending on power conditions. Refer to the Power section for details.
10	High / low limit indicators	Correspond to the programmed set points. Indicator definitions are as follows: ▲ – the displayed value is greater than the upper force limit ■ – the displayed value is between the limits ▼ – the displayed value is less than the lower force limit
11	Set points	The programmed force limits. Typically used for pass/fail type testing. One, two, or no indicators may be present, depending on the configuration shown in the Set Points menu item.

4.2 Controls

Primary Label	Primary Function	Secondary Label	Secondary Function
	Powers the gauge on and off. Press briefly to power on, press and hold to power off. Active only when the home screen is displayed.	ENTER	Various uses, as described in the following sections.
ROTATE	Reverses the orientation of the display.	DIRECTION	Reverses the display during calibration, and toggles between tension and compression directions while configuring set points and other menu items.
ZERO	Zeroes the primary reading and peaks.	▲ (UP)	Navigates up through the menu and sub-menus.
MENU	Enters the main menu.	N/A	N/A
ESCAPE	Reverts one step backwards through the menu hierarchy.	N/A	N/A
DATA	Stores a value to memory and/or transmits the current reading to an external device, depending on setup.	DELETE	Enables and disables Delete mode while viewing stored data / shifts cursor to the right for certain functions.
MODE	Toggles between measurement modes.	▼ (DOWN)	Navigates down through the menu and sub-menus.

4.3 Menu navigation basics

Most of the gauge's various functions and parameters are configured through the main menu. To access the menu press **MENU**. Use the ▲ and ▼ keys to scroll through the items. The current selection is denoted with clear text over a dark background. Press **ENTER** to select a menu item, then use ▲ and ▼ again to scroll through the sub-menus. Press **ENTER** again to select the sub-menu item.

For parameters that may be either selected or deselected, press **ENTER** to toggle between selecting and deselecting. An asterisk (*) to the left of the parameter label is used to indicate when the parameter has been selected.

For parameters requiring the input of a numerical value, use the ▲ and ▼ keys to increment or decrement the value. Press and hold either key to auto-increment at a gradually increasing rate. When the desired value has been reached, press **ENTER** to save the change and revert back to the sub-menu item, or press **ESCAPE** to revert back to the sub-menu item without saving. Press **ESCAPE** to revert one step back in the menu hierarchy until back into normal operating mode.

Refer to the following sections for details about setting up particular functions and parameters.

5 SET POINTS

5.1 General Information

Set points are useful for pass / fail testing. Two limits, high and low, may be specified. The gauge compares the primary reading to these limits, providing “under”, “in range”, and “over” indication.

5.2 Configuration

To configure set points, select **Set Points** from the menu. The screen appears as follows:

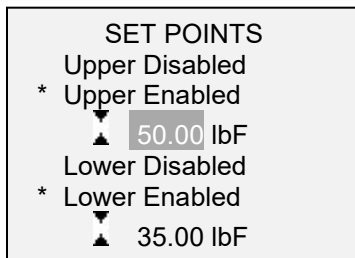

One, two, or none of the set points may be enabled. To toggle between the tension and compression directions, press the **DIRECTION** key.

If two set points have been enabled, they are displayed in the upper left corner of the display. If only one set point has been enabled, the word “OFF” appears in place of the value. If no set points have been enabled, the upper left corner of the display will be blank.

When set points are enabled, the following indicators are shown to the left of the primary reading:

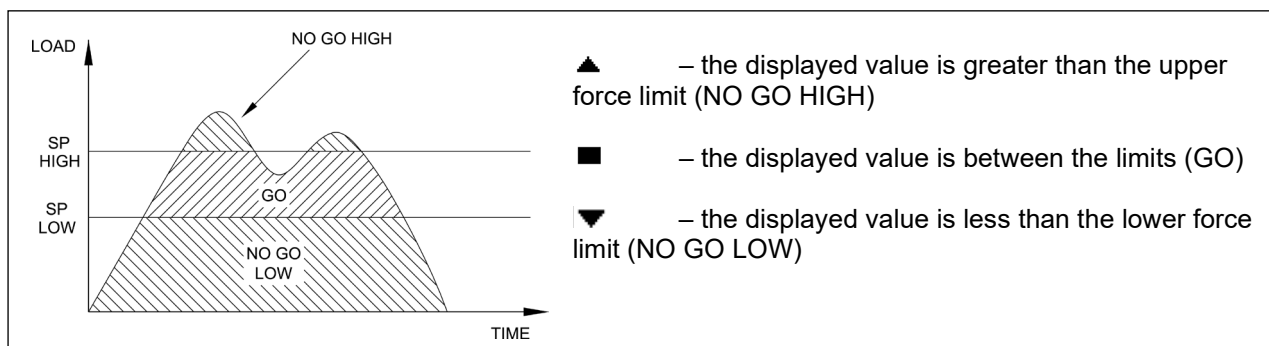

Note: Set point indicators and outputs reference the displayed reading, not necessarily the current live load.

6 OPERATING MODES

Caution!

In any operating mode, if the capacity of the instrument has been exceeded by more than 110%, the display will show “OVER” to indicate an overload. A continuous audible tone will be sounded until the MENU key has been pressed or the load has been reduced to a safe level.

Several operating modes are possible with Series E gauges, as follows:

- **Real Time (RT)**
- **Peak Compression (PC)**
- **Peak Tension (PT)**
- **Average Mode (AVG)**
- **Data Capture (CAPT)**

To cycle between the modes, press **MODE** while in the home screen. Refer to the following sections for details for each mode:

6.1 Real Time (RT)

The primary reading corresponds to the live measured reading.

6.2 Peak Compression (PC)

The primary reading corresponds to the peak compression reading observed. If the actual force decreases from the peak value, the peak will still be retained in the primary reading area of the display. Pressing **ZERO** will reset the value.

6.3 Peak Tension (PT)

This is the same as Peak Compression, but for tension readings.

6.4 Average Mode (AVG)

Calculates the average force reading over a period of time. Before the parameters of Average Mode can be configured, it must be enabled. To do so, select **Average Mode** from the menu, scroll to **Enabled** and press **ENTER**. The display appears as follows:

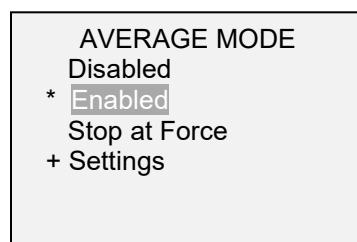

The averaging function operates in one of two ways:

1. Averaging occurs between the trigger force and defined time limit, as illustrated below:

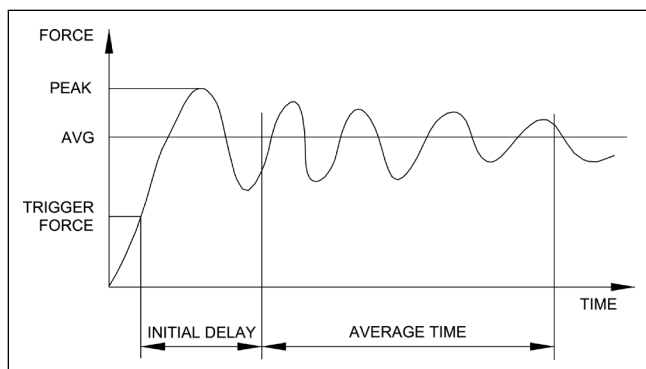

- Averaging occurs only while above the trigger force. As the force drops back down to this trigger, averaging stops. To enable this function, scroll to **Stop at Force** and press **ENTER**.

Select **Settings** to configure **Trigger Force**, **Initial Delay**, and **Averaging Time**:

AVERAGE MODE SETTINGS	
Trigger Force	▲
▼ 1.00 lbF	
Initial Delay	
1.0 sec.	
Averaging Time	
5.0 sec.	

Parameter	Description
Trigger Force or Start / Stop Force	The minimum force required to start the averaging sequence. Toggle between compression and tension directions by pressing the DIRECTION key. Initial delay follows the trigger force. If Stop at Force is enabled, this parameter is referred to as Start / Stop Force , denoting the minimum force for which averaging will be active.
Initial Delay	The time delay, after the trigger force, before the averaging sequence commences. <i>Available settings: 0.0 – 300.0 sec., in 0.1 sec. increments</i>
Averaging Time	The time duration of the averaging sequence. This setting is ignored when Stop at Force is enabled, unless the 300 sec. limit is reached. <i>Available settings: 0.1 – 300.0 sec., in 0.1 sec. increments</i>

After the parameters have been configured and the menu has been exited, press **MODE** until **AVG** is displayed. Then press **ZERO**. Average mode is now armed, and the averaging sequence will commence when the trigger force has occurred. The current status of the averaging sequence is displayed below the primary reading, as follows:

Step	Status	Description
1	TRIG WAIT	The trigger force has not yet occurred.
2	INIT DLY	The initial delay is currently taking place.
3	AVERAGING	The gauge is collecting readings. The status will be flashing until averaging has been completed.
4	AVRG DONE	Averaging has been completed. The average force is displayed in the primary reading.

At the completion of the averaging sequence, the peak values are retained until **ZERO** is pressed. Another averaging sequence may be started after **ZERO** has been pressed. To exit Average mode, press **MODE** and select the desired measuring mode.

6.5 Data Capture (CAPT)

This mode of operation is used to capture and store continuous data in the gauge's memory. The capture frequency can be adjusted to accommodate quick-action as well as longer duration tests. Saved data can be downloaded in bulk via USB.

6.5.1 Configuration

After Data Capture has been enabled, it may be selected by pressing the **MODE** key until **CAPT** is displayed. The display appears as follows:

<p>DATA CAPTURE</p> <p>* Enabled</p> <p>Period (H:M:S.x)</p> <p>00 :00 :00 .00007</p> <p>+ Start Condition</p> <p>+ Stop Condition</p>
--

Function	Description
Enabled	If enabled, CAPT appears as one of the operating modes.
Period	The capture period may be adjusted by pressing the ▲ and ▼ keys to change the value of the hours (H), minutes (M), seconds (S), and fractions of seconds (x) fields. Press the DATA key to advance to the next field. Available settings: <i>Hours: 0-24, Minutes: 0-59, Seconds: 0-59, Fraction of Seconds: 0.00007-0.99995, in 0.00007 (70 μS) increments.</i>
Start Condition	See following sub-section for details.

6.5.2 Start Condition

Data capture is initiated when the Start Condition has been triggered. Several triggers are available, as shown below:

<p>START CONDITION</p> <p>Start Force</p> <p>▲ 3.50 lbF</p> <p>* DATA Key</p>

Function	Data capture is initiated when:
Start Force	The desired trigger force is reached. Toggle between compression and tension directions by pressing the DIRECTION key.
DATA Key	The DATA key is manually pressed.

6.5.3 Stop Condition

Data capture is automatically terminated when the Stop Condition has been reached. Several conditions are available, as shown below:

STOP CONDITION
* Samples: 10
Stop Force
▲ 100.00 lbf
Memory Full
DATA Key

Function	Data capture terminates when:
Samples	The desired number of samples (data points) has been captured.
Stop Force	The desired force has been reached.
Memory Full	5,000 data points have been captured.
DATA Key	The DATA key is manually pressed.

Note 1: If the Stop Condition does not occur, data capture stops automatically when the memory is full.

Note 2: Data capture may be manually stopped at any time by pressing the **ZERO** key. A message will appear at the bottom of the screen: "CAPTURE CANCELLED".

The first or subsequent Data Capture sequences cannot occur until the **ZERO** key is pressed to arm data capture, or until the gauge is automatically re-armed (see the following sub-section for details). If another Data Capture sequence is initiated before the memory is cleared, these data points are appended to the existing data stored in memory.

7 DATA MEMORY AND STATISTICS

Series E gauges have storage capacity of 5,000 data points. Readings may be stored, viewed, and output to an external device. Individual or all data points may be deleted. Statistics are calculated for the data in memory.

To enable memory storage, select **DATA Key** from the menu, then scroll to **Memory Storage** and press **ENTER**. Then exit the menu. In the home screen, the data record number **0000** appears below the primary reading. Press **DATA** at any time to save the displayed reading. The record number will increment each time **DATA** is pressed. If **DATA** is pressed when memory is full the message "MEMORY FULL" will be flashed at the bottom of the display and a double audio tone will be sounded.

To view, edit, and output stored readings and statistics, select **Memory** from the menu. The screen appears as follows:

MEMORY
View Data
View Statistics
Output Data
Output Statistics
Output Data & Stats
Clear All Data

7.1 View Data

All the saved data points may be viewed. The record number is displayed, along with the corresponding value and currently set unit of measurement. Any readings may be deleted individually. To do so, scroll to the desired reading and press **DELETE**. The letter “D” appears to the left of the record number, indicating that the gauge is in **Delete** mode, as follows:

0001	24.58 lbF
0002	22.24 lbF
0003	24.46 lbF
0004	18.90 lbF
D 0005	20.98 lbF
0006	19.98 lbF
0007	20.42 lbF

Press **ENTER** to delete the value. To exit **Delete** mode, press **DELETE** again. Any number of readings may be individually deleted, however, all readings may also be cleared simultaneously. Refer to the **Clear All Data** section for details.

7.2 Statistics

Statistical calculations are performed for the saved values. Calculations include number of readings, minimum, maximum, mean, and standard deviation.

7.3 Output Data *

Press **ENTER** to output data to an external device. The display will show, “SENDING DATA...”, then “DATA SENT”. If there was a problem with communication, the display will show, “DATA NOT SENT”.

7.4 Output Statistics *

Press **ENTER** to output statistics to an external device. The display will show, “SENDING STATS...”, then “STATS SENT”. If there was a problem with communication, the display will show, “STATS NOT SENT”.

7.5 Output Data & Stats *

Press **ENTER** to output data and statistics to an external device. The display will show, “SENDING DATA”, then “SENDING STATS...”, then “DATA SENT”, then “STATS SENT”. If there was a problem with communication, the display will show, “DATA NOT SENT” and/or “STATS NOT SENT”.

* When using Mark-10 data collection programs MESUR™ Lite and MESUR™gauge, bulk data may be transferred only by clicking the appropriate button within the program, not by initiating the transfer from the gauge via these functions. These functions are designed for third party applications.

7.6 Clear All Data

Press **ENTER** to clear all data from the memory. A prompt will be shown, “CLEAR ALL DATA?”. Select **Yes** to clear all the data, or **No** to return to the sub-menu.

Shortcut for clearing all data: In the main menu, highlight **Memory** and press **DELETE**. The same prompt will be shown as above.

Note: Data is not retained while the gauge is powered off. However, the gauge protects against accidental data loss by displaying the following prompt when attempting to power off:



If no option is selected, this screen will be displayed continuously until battery power has been depleted. The **Automatic Shutoff** setting is ignored if there is data in the memory.

8 COMMUNICATIONS AND OUTPUTS

Communication with Series E gauges is achieved through the micro USB port, as shown in the illustration in the **Power** section. Communication is possible only when the gauge is in the main operating screen (i.e. not in a menu or configuration area).

8.1 USB Settings

To configure USB settings, select **USB Settings** from the menu. The display appears as follows:

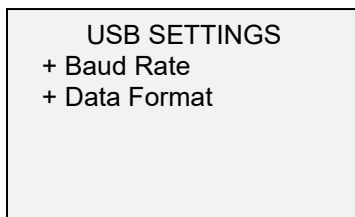

Communication settings are permanently set to the following:

Data Bits:	8
Stop Bits:	1
Parity:	None

Other settings are configured as follows:

8.1.1 Baud Rate

Select the baud rate as required for the application. It must be set to the same value as the receiving device.

8.1.2 Data Format

Select the desired data format. The display appears as follows:

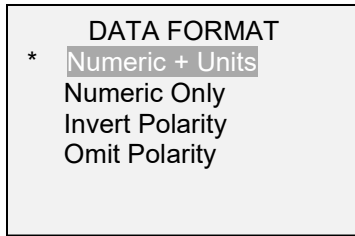

Selection	Description
Numeric + Units	Output format includes the value and unit of measure.
Numeric Only	Output format includes the value only.
Invert Polarity	Compression values have negative polarity, tension values have positive polarity. May be selected in addition to the Numeric + Units / Numeric Only selection.
Omit Polarity	Both directions are formatted with positive polarity. May be selected in addition to the Numeric + Units / Numeric Only selection.

8.1.3 Data Communication

Individual data points may be transmitted by pressing **DATA**. Individual data points and continuous data may be requested from Mark-10 MESUR™ Lite and MESUR™gauge software.

The gauge may also be controlled by an external device. The following is a list of supported commands and their explanations. All commands must be terminated by a CR (Carriage Return) character, 0x0D, or a CR-LF (Carriage Return – Line Feed) pair, where the Line Feed, 0x0A, is ignored.

?	Request the displayed reading
MEM	Transmit all stored readings
STA	Transmit statistics
CLRMEM	Delete all stored readings from memory

8.1.4 Command Responses

In response to the reading request command '?' the tester will return a string with the load data, followed by a space, then the load unit (if enabled, as described above). It will be terminated by a CR-LF pair.

Example return strings:

```
-18.78 lbF<CR><LF> 18.78 lbF of tension force
172.40 N<CR><LF> 172.40 N of compression force
```

The number of digits after the decimal point is dependent of the gauge's resolution.

Any detected errors are reported back by means of error code *10 (illegal command).

8.2 DATA Key Functions

The **DATA** key can be configured to perform two functions when pressed. To configure the **DATA** key, select **DATA Key** from the menu. The display appears as follows:

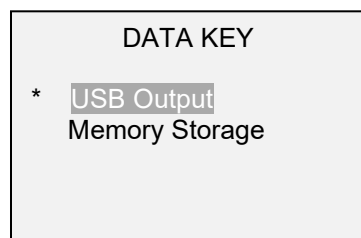

Selection	Function when pressing DATA
USB Output	Outputs the current displayed value via the USB port
Memory Storage	Stores a reading to memory (refer to the Memory section for details)

9 CALIBRATION

9.1 Initial Physical Setup

The gauge should be mounted vertically to a test stand or fixture rugged enough to withstand a load equal to the full capacity of the instrument. Certified deadweights or master load cells should be used, along with appropriate mounting brackets and fixtures. Caution should be taken while handling such equipment.

9.2 Calibration Procedure

1. Select **Calibration** from the menu. The display appears as follows:

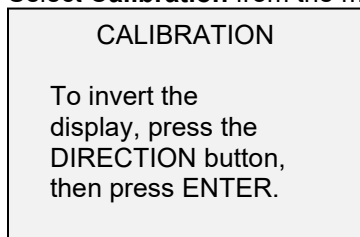

2. Press **DIRECTION** to invert the display, if desired. **ENTER** to continue. The display appears as follows:

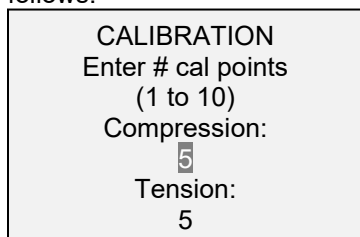

The gauge can be calibrated at up to 10 points in each direction. Enter the number of calibration points for each direction (compression and tension). At least one point must be selected for each direction.

Note: To achieve the accuracy specification of $\pm 0.2\%$, it is recommended to calibrate the gauge at 5 or more even increments in both tension and compression directions. For example, a gauge with capacity of 100 lbF should be calibrated at 20, 40, 60, 80, and 100 lb loads in each direction.

3. To escape the **Calibration** menu at any time, press **ESCAPE**. The display appears as follows:

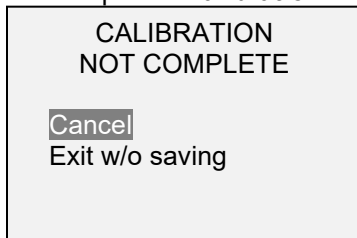

Selecting **Cancel** will revert back to the Calibration setup. Selecting **Exit w/o saving** will return to the menu without saving changes.

4. After the number of calibration points has been entered, press **ENTER**. The display appears as follows:

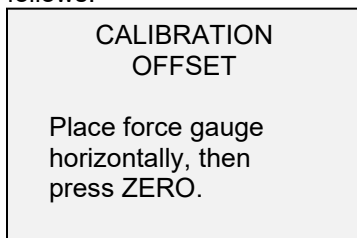

5. Place the force gauge horizontally on a level surface free from vibration, then press **ZERO**. The gauge will calculate internal offsets, and the display appears as follows:

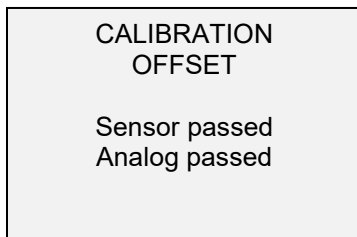

If failed:

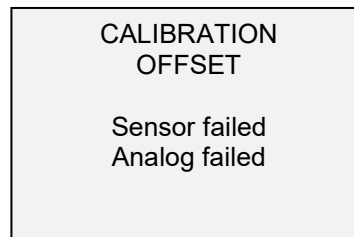

6. The following screen appears after the offsets have been calculated:



Attach weight fixtures (brackets, hooks, etc), as required. Do not yet attach any weights or apply any calibration loads. Press **ENTER**.

7. The display appears as follows:

```
CALIBRATION
COMPRESSION

Optionally exercise
sensor, then press
ENTER.
```

Optionally exercise the load cell shaft several times (at full scale, if possible), then press **ENTER**.

8. The display appears as follows:

```
CALIBRATION
COMPRESSION
Gain adjust
Apply full scale load
100.00 lbF +/-20%,
then press ENTER.
```

Apply a weight equal to the full scale of the instrument, then press **ENTER**.

9. After displaying "Please wait..." the display appears as follows:

```
CALIBRATION
COMPRESSION

Ensure no load,
then press ZERO.
```

Remove the load applied in Step 8, leave the fixtures in place, then press **ZERO**.

10. The display appears as follows:

```
CALIBRATION
COMPRESSION
Apply load
1 OF 5
Enter load:
20.00 lbF
Press ENTER.
```

Use the ▲ and ▼ keys to adjust the load value as required. The load values default to even increments, as indicated by the previously entered number of data points (even increments are recommended for best results). For example, if a 100 lbF capacity gauge is calibrated, and 5 data points were selected, the load values will default to 20, 40, 60, 80, and 100 lb. Apply the calibration load. Then press **ENTER**.

Repeat the above step for the number of data points selected.

11. After all the compression calibration points have been completed, the display appears as follows:

CALIBRATION
COMPRESSION COMPLETE
Reverse direction
for tension.
Attach necessary
weight fixtures,
then press ENTER.

Press **ENTER**.

12. The display appears as follows:

CALIBRATION

To invert the
display, press the
DIRECTION button,
then press ENTER

Reverse the orientation of the load cell shaft by rotating the gauge 180 degrees. Press **DIRECTION** to invert the display. Then attach weight fixtures. The following screens will step through the same procedure as with the compression direction. Proceed in the same manner.

13. At the completion of the tension calibration, the display appears as follows:

CALIBRATION
COMPLETE

Save & exit
Exit w/o saving

To save the calibration information, select "Save & exit". To exit without saving the data select "Exit without saving".

14. Any errors are reported by the following screens:

CALIBRATION

Units must be gF.

Please try again
Press ENTER.

Displayed at the start of calibration if a disallowed unit is selected.

CALIBRATION
Load not stable.
Please try again.

Ensure that the load is not swinging, oscillating, or vibrating in any manner. Then try again.

CALIBRATION
COMPRESSION
Load too low.
Please try again.

The calibration weight does not match the set value.

CALIBRATION
TENSION
Load too close
to previous.
Please try again.

The entered calibration point is too close to the previous point.

10 PASSWORDS

Two separate passwords may be set to control access to the Calibration section and to the menu and other keys. To access the passwords setup screen, select **Passwords** from the menu. The display appears as follows:

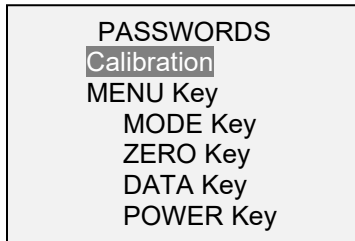

10.1 Calibration Password

Select **Calibration** from the sub-menu. The display appears as follows:

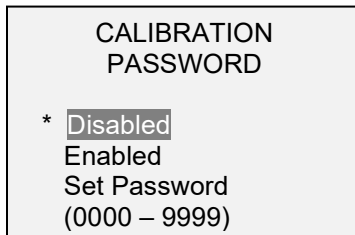

To set the password, select **Enabled**, then **Set Password**. Use the ▲ and ▼ keys to increment and decrement the value, from 0 to 9999. When the desired value has been selected, press **ENTER**, then **ESCAPE** to exit the sub-menu.

10.2 MENU Key Password

If enabled, every time the **MENU** key is selected, a password must be provided. Select **Menu Key** from the sub-menu. Follow the same procedure as described above.

10.3 Locking Out Other Keys

Other keys may be locked out individually. Pressing a locked key will prompt the message “KEY PROTECTED” and then revert to the previous screen.

10.4 Password Prompts

If passwords have been enabled, the following will be displayed when pressing the **MENU** key or accessing the **Calibration** section:

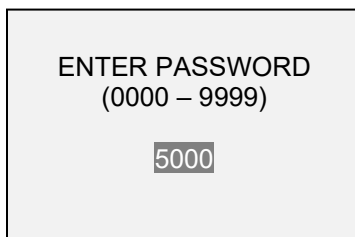

Use the ▲ and ▼ keys to select the correct password, then press **ENTER** to continue.

If the incorrect password has been entered, the display appears as follows:

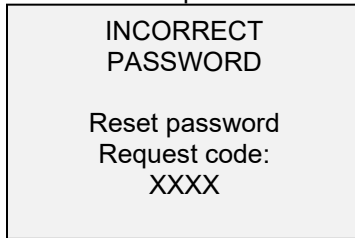

To re-enter the password, press **ESCAPE** to exit to the home screen. Then, access the desired function and enter the password again when prompted.

If the password has been misplaced, it can be reset. Press **ENTER** to generate a *request code*. The *request code* must be supplied to Mark-10 or a distributor, who will then provide a corresponding *authorization code*. Enter the *activation code* to disable the password.

11 OTHER SETTINGS

11.1 Automatic Shutoff

The gauge may be configured to automatically power off following a period of inactivity while on battery power. Inactivity is defined as the absence of any key presses or load changes of 100 counts or less. To access these settings, select **Automatic Shutoff** from the menu. The display appears as follows:



Selection	Description
Disabled	Disable automatic shutoff.
Enabled	Enable automatic shutoff.
Set Minutes	The length of time of inactivity. Available settings: 5-30, in 5 minute increments.

Note: If the AC adapter is plugged in, the gauge will ignore these settings and remain powered on until the **POWER** key is pressed.

11.2 Backlight

Although the backlight may be turned on and off at any time by pressing the **BACKLIGHT** key, there are several available initial settings (applicable upon powering on the gauge). To access these settings, select **Backlight** from the menu. The display appears as follows:



Selection	Description
Off	Backlight to be off upon powering on the gauge.
On	Backlight to be on upon powering on the gauge.
Auto	Backlight to be on upon powering gauge, but will shut off after a period of inactivity (as defined in the Automatic Shutoff sub-section). The backlight will turn on again when activity resumes. The length of time of inactivity is programmed in minutes via the Set Minutes parameter. Available settings: 1-10, in 1 minute increments.

Note: If the AC adapter is plugged in, the gauge will ignore these settings and keep the backlight on.

11.3 LCD Contrast

The contrast of the display may be adjusted. Select **LCD Contrast** from the menu. The screen appears as follows:



Press **ENTER** to modify the contrast. Select a value from 0 to 25, 25 producing the most contrast.

11.4 Tones

Audible tones can be enabled for all key presses and alerts, such as overload, set point value reached, etc. The Set Point alert can be configured to be either a momentary tone or a continuous tone (until the load is restored to a value between the set points). To configure the functions for which audible tones will apply, select **Tones** from the menu. The screen appears as follows:

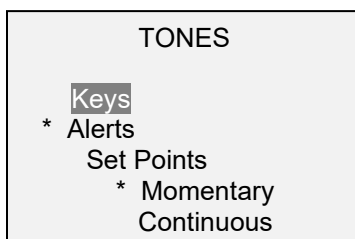

11.5 Initial settings

This section is used to configure the initial settings upon powering on the gauge. The initial units of measurement and the primary reading measurement mode may be configured. To access these settings, select **Initial Settings** from the menu. The screen appears as follows:

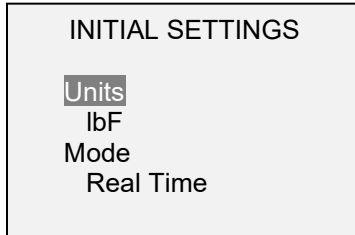

11.6 Restore Default Settings

Default factory settings can be restored by selecting **Restore Defaults** from the menu. The settings may be found in the **Specifications** section. The screen appears as follows:

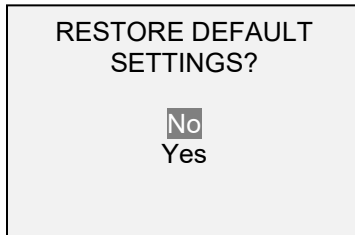

11.7 Information / Welcome Screen

The following screen is displayed at power-up and can be accessed at any time by selecting **Information** from the menu:

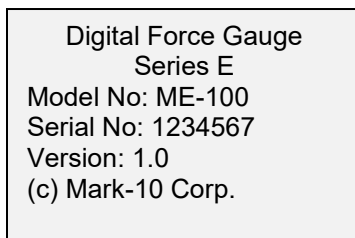

12 SPECIFICATIONS

12.1 General

Accuracy:	±0.2% of full scale
Sampling rate:	7,000 Hz
Power:	AC or rechargeable battery. Low battery indicator appears when battery level is low, and gauge powers off automatically when power reaches critical stage.
Battery life:	Backlight on: up to 7 hours of continuous use Backlight off: up to 24 hours of continuous use
Measurement units:	lbF, ozF, gF, kgF, N, kN (depending on model)
USB output:	Configurable up to 115,200 baud
Safe overload:	200% of full scale (display shows "OVER" at 110% and above)
Weight:	1.7 lb [0.8 kg]
Environmental requirements:	40 - 100°F, max. 93% humidity, non-condensing
Warranty:	3 years (see individual statement for further details)
Literature & Software:	Download at: www.mark-10.com/downloads

12.2 Factory Default Settings

Parameter	Setting
Set points	
Upper	Disabled (defaults to 80% of full scale, compression, when enabled)
Lower	Disabled (defaults to 40% of full scale, compression, when enabled)
Average mode	Disabled
Initial Delay	0
Trigger Force	10% of full scale
Averaging Time (sec.)	5.0
DATA Key Functions	
USB Output	Enabled
Memory Storage	Enabled
USB Settings	
Baud Rate	115,200
Data Format	Numeric + Units
Data Capture	Disabled
Period	00:00:01:00000
Start Condition	Start force of 10% of full scale
Stop Condition	Stop force of 20% of full scale
Auto Settings	All disabled
Tones	
Keys	Enabled
Alerts	Enabled
Set Points	Momentary
Automatic Shutoff	Enabled
Set Minutes	5
Backlight	Auto
Set Minutes	1
Initial Settings	
Units	lbF
Mode	Real Time
Passwords	All disabled

12.3 Capacity x Resolution

Model	lbF	ozF	kgF	gF	N	kN
ME-100	100 x 0.05	1600 x 1	50 x 0.02	50000 x 20	500 x 0.2	-
ME-200	200 x 0.05	3200 x 1	100 x 0.02	-	1000 x 0.2	1 x 0.0002
ME-500	500 x 0.1	8000 x 2	250 x 0.05	-	2500 x 0.5	2.5 x 0.0005

12.4 Dimensions

IN [MM]

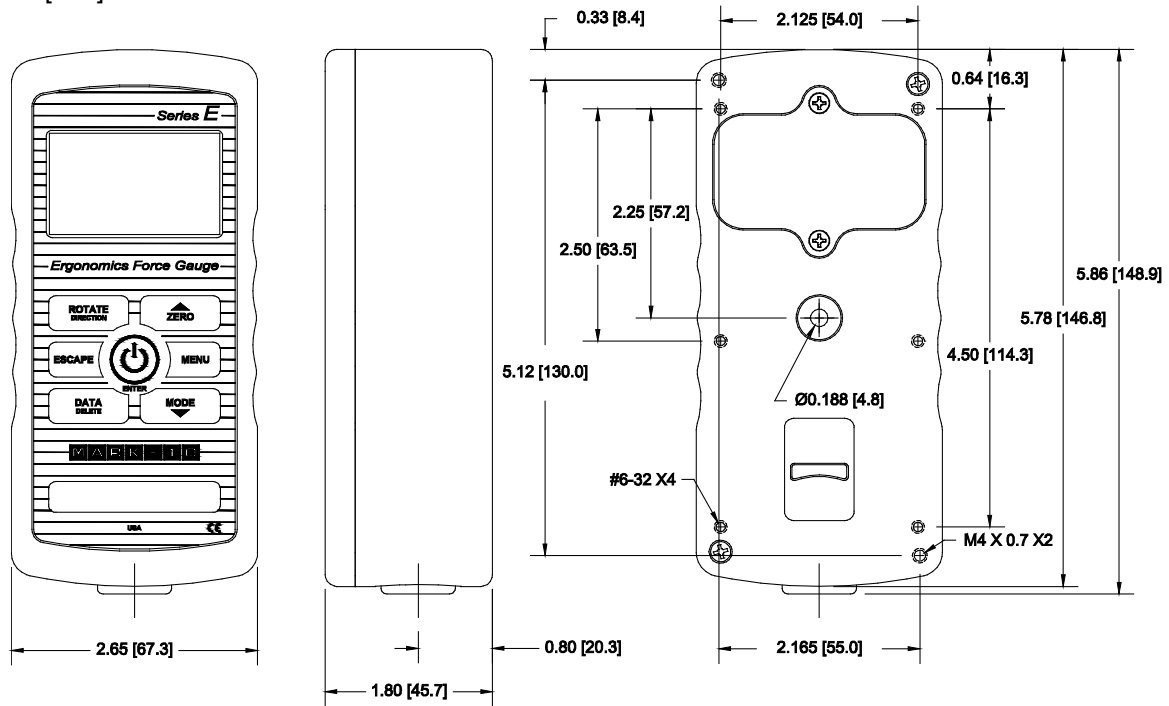

NOTES:



Mark-10 Corporation has been an innovator in the force and torque measurement fields since 1979. We strive to achieve 100% customer satisfaction through excellence in product design, manufacturing and customer support. In addition to our standard line of products we can provide modifications and custom designs for OEM applications. Our engineering team is eager to satisfy any special requirements. Please contact us for further information or suggestions for improvement.



Force and torque measurement engineered better

Mark-10 Corporation

11 Dixon Avenue
Copiague, NY 11726 USA
1-888-MARK-TEN
Tel: 631-842-9200
Fax: 631-842-9201
Internet: www.mark-10.com
E-mail: info@mark-10.com